

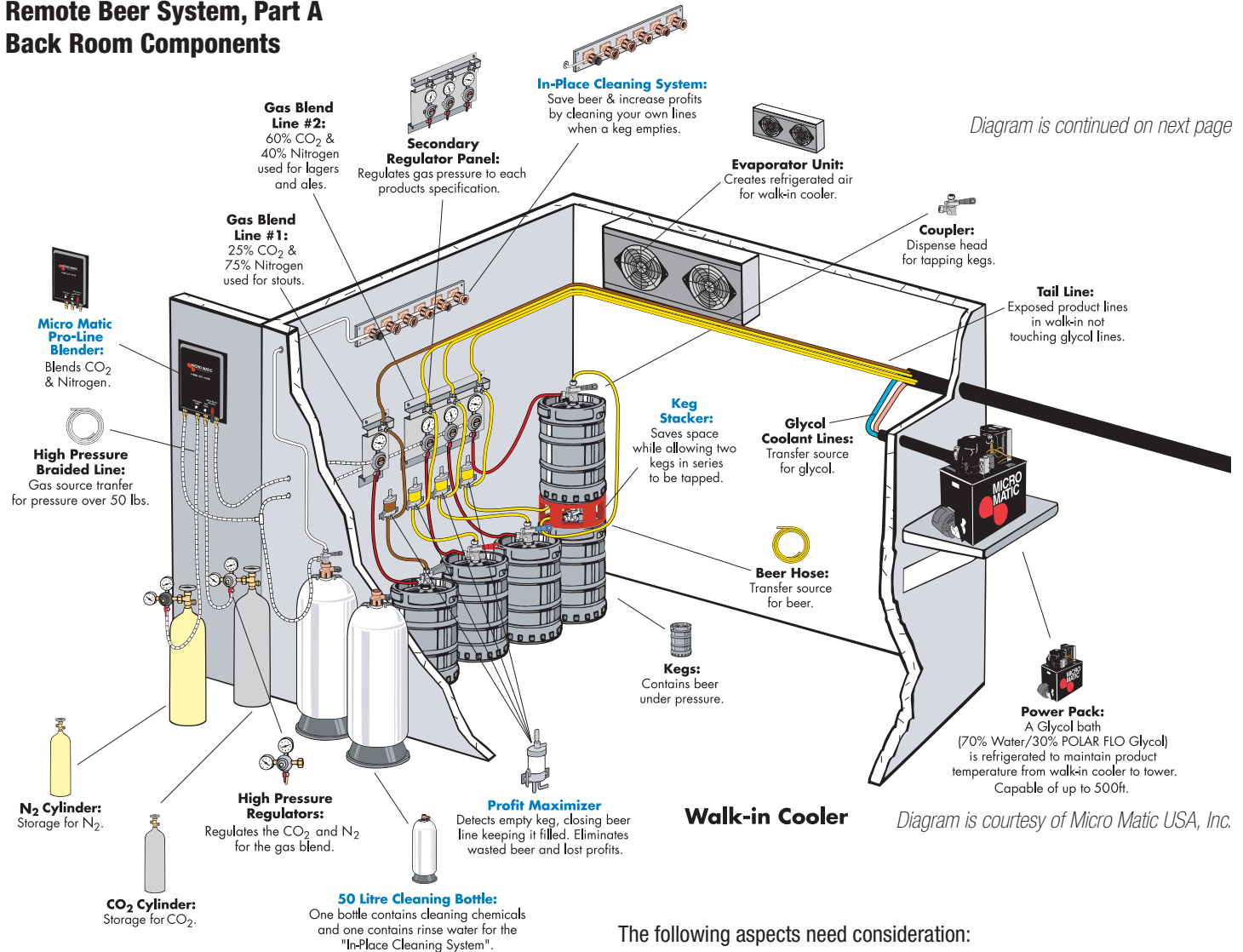

BAR EQUIPMENT

1. Towers, Drip Trays, Faucets, Handles, Shanks, Bar Guns, Portion Control, Frozen Drink Maker, Cold Plates
2. Couplers, Pumps, Chillers, Gas Blenders, CO₂ Tanks & Alarm, Regulators, Conduit, Fittings
3. Under Bar, Cocktail Stations, Glasswashers, Bar Refrigeration, Back Bar Miscellaneous
4. Cleaners, Accessories, Installer Checklist

Remote Beer System, Part A Back Room Components



To design your remote draft beer system, knowledge of your basic requirements is necessary. Our sales people are eager to discuss the various options to fit your needs and budget. Please feel free to contact us with any questions.

The following aspects need consideration:

- Total length of the run(s)
- Location and layout of the beer line chase-way(s)
- Net vertical lift or drop (distance from bottom of keg to beer faucet)
- Number of dispensing stations, the type of beer tower(s), and the number of faucets on each tower
- Number of kegs to be stored in the walk-in cooler
- Line chiller location and if a line chiller leg set, stand or wall rack is required
- Method of counter pressure: beer pumps or blended N₂/CO₂
- Type of primary CO₂ storage: tank or bulk
- If kege taps are required or supplied by others



BAR EQUIPMENT

Remote Beer System, Part B

An installer checklist can be found on the last 2 pages of this section to help build a complete beer dispensing system.

Cut-Away View KOOL-RITE TECHNOLOGY Drop-In Module Fabrication

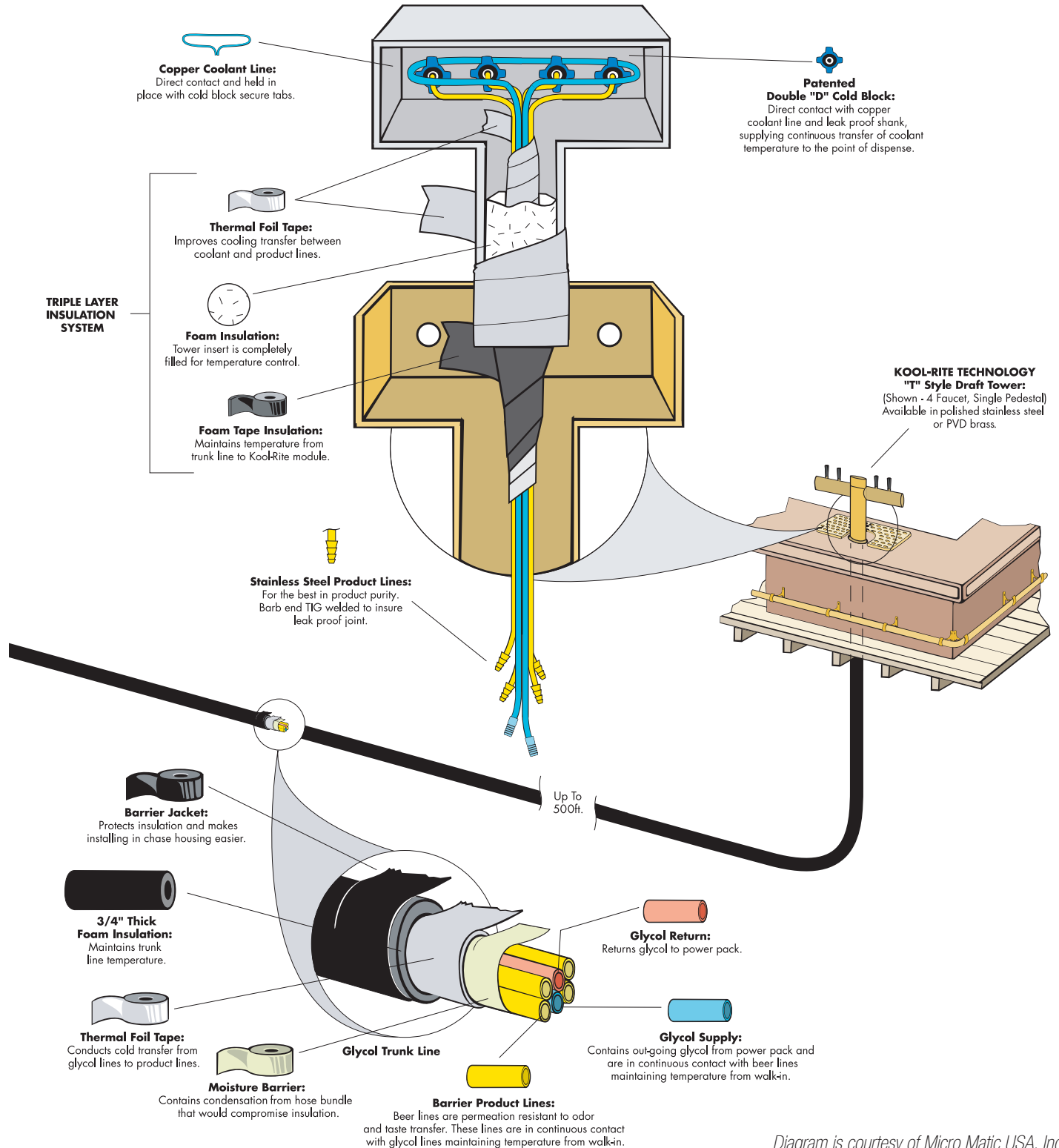

Diagram is courtesy of Micro Matic USA, Inc.



BAR EQUIPMENT

Wall Mounted Direct Draw System, Part A Back Room Components

An installer checklist can be found on the last 2 pages of this section to help build a complete beer dispensing system.

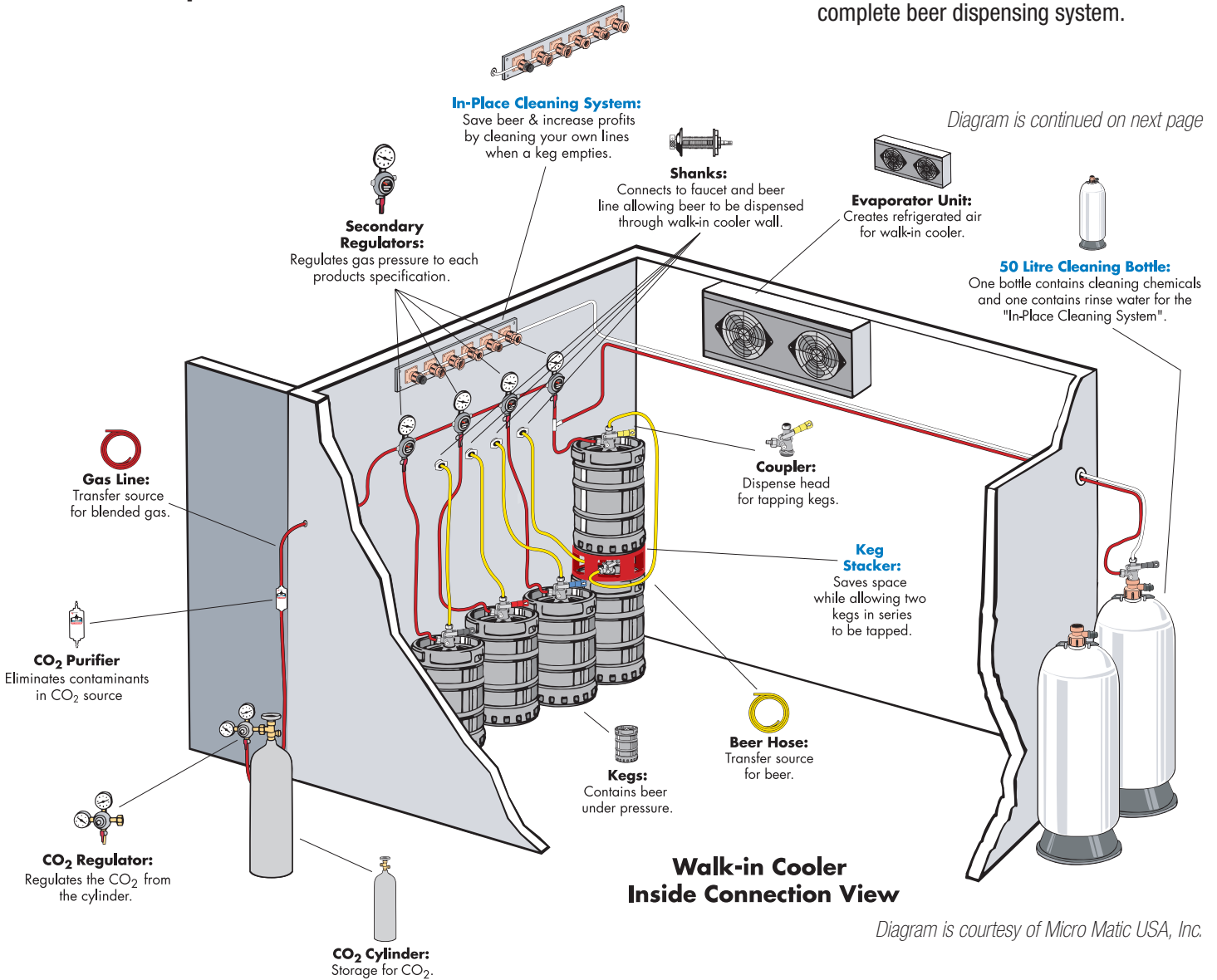

To design your remote draft beer system, knowledge of your basic requirements is necessary. Our sales people are eager to discuss the various options to fit your needs and budget. Please feel free to contact us with any questions.

The following aspects need consideration:

- Total length of the run(s)
- Location and layout of the beer line chase-way(s)
- Net vertical lift or drop (distance from bottom of keg to beer faucet)
- Number of dispensing stations, the type of beer tower(s), and the number of faucets on each tower
- Number of kegs to be stored in the walk-in cooler
- Line chiller location and if a line chiller leg set, stand or wall rack is required
- Method of counter pressure: beer pumps or blended N₂/CO₂
- Type of primary CO₂ storage: tank or bulk
- If keg taps are required or supplied by others



BAR EQUIPMENT

Wall Mounted Direct Draw System, Part B

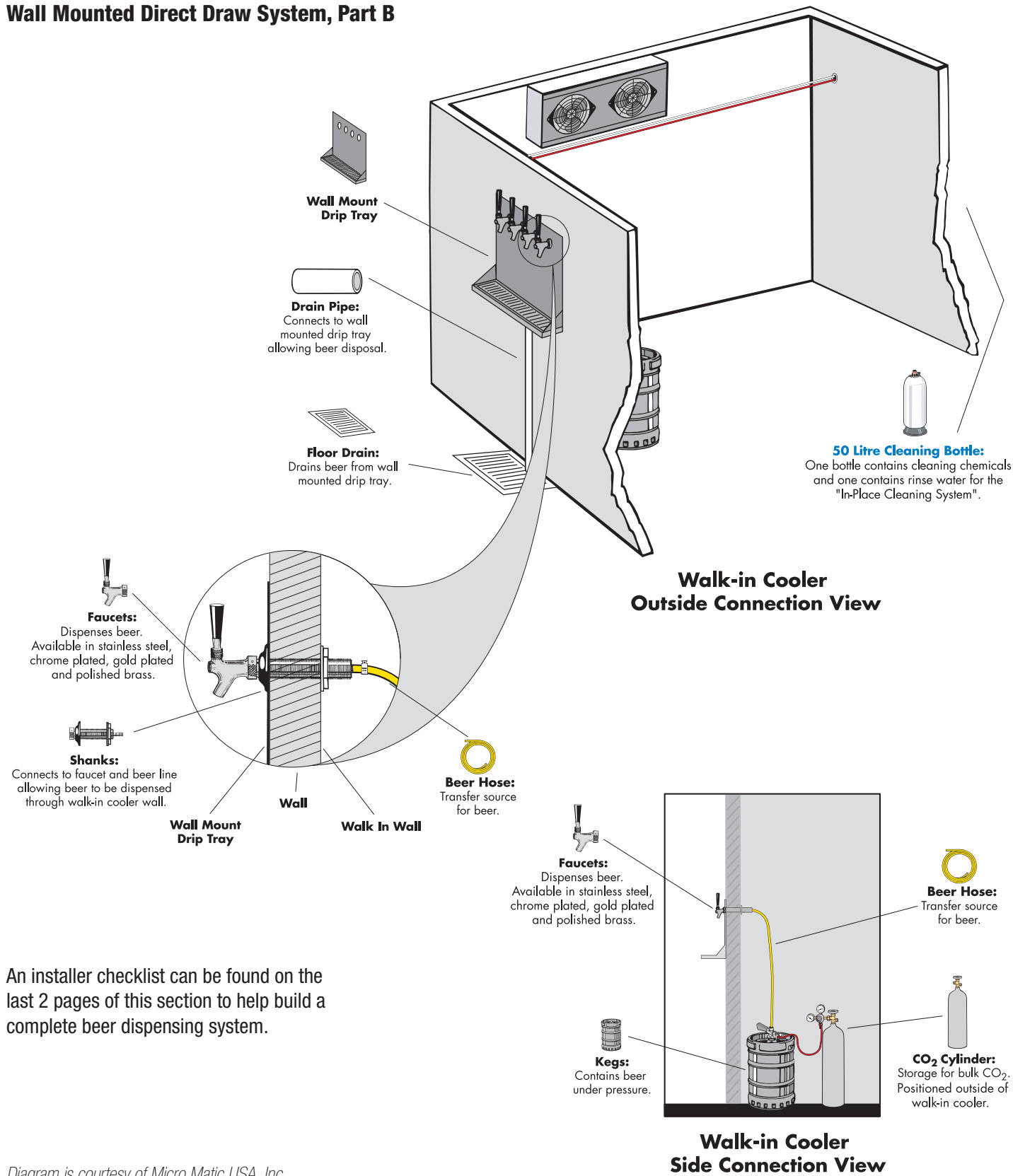

An installer checklist can be found on the last 2 pages of this section to help build a complete beer dispensing system.

Diagram is courtesy of Micro Matic USA, Inc.



Beer Dispensing Towers

One, two, or three faucet column towers come with integral surface mount drain pan and lift-out perforated inserts. Available with wine faucets; specify number and location when ordering. For foamed-in-place cold plate assembly for glycol recirculating system, add suffix "R" to the model number. If you prefer a tower without a drain pan add suffix "-LD" to the model number.

Choose from 3 finishes: grainline stainless (SS), mirror finish stainless (MF), or polished brass (PB). Stainless and mirror finish models include all stainless steel faucets and shanks.

Dispensers have a unique internal support system for solid mounting. Base plate serves as template for hole cutting. Uses 1/4" ID shanks with 3/16" fittings.



Column tower, SS finish



Tee tower, SS finish



Tee tower, polished brass



Pass-thru tower, mirror finish

Part Number	Faucets	Finish	Cooling	Description	Drip Tray
CT1SS	1	Stainless steel	Air	Column tower, grainline stainless finish	Included
CT1MF	1	Mirror	Air	Column tower, mirror finish stainless	Included
CT1PB	1	Polished brass	Air	Column tower, polished brass finish	Included
CT1SSR	1	Stainless steel	Glycol	Column tower, grainline stainless finish	Included
CT1MFR	1	Mirror	Glycol	Column tower, mirror finish stainless	Included
CT1PBR	1	Polished brass	Glycol	Column tower, polished brass finish	Included
CT2SS	2	Stainless steel	Air	Column tower, grainline stainless finish	Included
CT2MF	2	Mirror	Air	Column tower, mirror finish stainless	Included
CT2PB	2	Polished brass	Air	Column tower, polished brass finish	Included
CT2PBLD	2	Polished brass	Air	Column tower, polished brass finish, no drip tray	N/A
CT2SSR	2	Stainless steel	Glycol	Column tower, grainline stainless finish	Included
CT2MFR	2	Mirror	Glycol	Column tower, mirror finish stainless	Included
CT2PBR	2	Polished brass	Glycol	Column tower, polished brass finish	Included
CT3SS	3	Stainless steel	Air	Column tower, grainline stainless finish	Included
CT3MF	3	Mirror	Air	Column tower, mirror finish stainless	Included
CT3PB	3	Polished brass	Air	Column tower, polished brass finish	Included
CT3SSR	3	Stainless steel	Glycol	Column tower, grainline stainless finish	Included
CT3MFR	3	Mirror	Glycol	Column tower, mirror finish stainless	Included
CT3PBR	3	Polished brass	Glycol	Column tower, polished brass finish	Included



BAR EQUIPMENT



Beer Dispensing Towers

Available with wine faucets; specify number and location when ordering. If you prefer a tower without a drain pan add suffix “-LD” to the model number.



Part Number	Faucets	Finish	Cooling	Description	Drip Tray
BT4SS	4	Stainless steel	Air	T tower, grainline stainless finish	Included
BT4MF	4	Mirror	Air	T tower, mirror finish stainless	Included
BT4PB	4	Polished brass	Air	T tower, polished brass finish	Included
BT4SSR	4	Stainless steel	Glycol	T tower, grainline stainless finish	Included
BT4MFR	4	Mirror	Glycol	T tower, mirror finish stainless	Included
BT4PBR	4	Polished brass	Glycol	T tower, polished brass finish	Included
BT5SS	5	Stainless steel	Air	T tower, grainline stainless finish	Included
BT5MF	5	Mirror	Air	T tower, mirror finish stainless	Included
BT5PB	5	Polished brass	Air	T tower, polished brass finish	Included
BT5PBLD	5	Polished brass	Air	T tower, polished brass finish, no drip tray	N/A
BT5SSR	5	Stainless steel	Glycol	T tower, grainline stainless finish	Included
BT5MFR	5	Mirror	Glycol	T tower, mirror finish stainless	Included
BT5PBR	5	Polished brass	Glycol	T tower, polished brass finish	Included
BT6SS	6	Stainless steel	Air	T tower, grainline stainless finish	Included
BT6MF	6	Mirror	Air	T tower, mirror finish stainless	Included
BT6PB	6	Polished brass	Air	T tower, polished brass finish	Included
BT6SSR	6	Stainless steel	Glycol	T tower, grainline stainless finish	Included
BT6MFR	6	Mirror	Glycol	T tower, mirror finish stainless	Included
BT6PBR	6	Polished brass	Glycol	T tower, polished brass finish	Included
BT8SS	8	Stainless steel	Air	T tower, grainline stainless finish	Included
BT8MF	8	Mirror	Air	T tower, mirror finish stainless	Included
BT8PB	8	Polished brass	Air	T tower, polished brass finish	Included
BT8SSR	8	Stainless steel	Glycol	T tower, grainline stainless finish	Included
BT8MFR	8	Mirror	Glycol	T tower, mirror finish stainless	Included
BT8PBR	8	Polished brass	Glycol	T tower, polished brass finish	Included
BT10SS	10	Stainless steel	Air	T tower, grainline stainless finish	Included
BT10MF	10	Mirror	Air	T tower, mirror finish stainless	Included
BT10PB	10	Polished brass	Air	T tower, polished brass finish	Included
BT10SSR	10	Stainless steel	Glycol	T tower, grainline stainless finish	Included
BT10MFR	10	Mirror	Glycol	T tower, mirror finish stainless	Included
BT10PBR	10	Polished brass	Glycol	T tower, polished brass finish	Included
BT12SS	12	Stainless steel	Air	T tower, grainline stainless finish	Included
BT12MF	12	Mirror	Air	T tower, mirror finish stainless	Included
BT12PB	12	Polished brass	Air	T tower, polished brass finish	Included
BT12SSR	12	Stainless steel	Glycol	T tower, grainline stainless finish	Included
BT12MFR	12	Mirror	Glycol	T tower, mirror finish stainless	Included
BT12PBR	12	Polished brass	Glycol	T tower, polished brass finish	Included



Hand Crafted Ceramic Towers



Rembrant



Black Forest



Vienna



Vienna Ellipse



Braumeister



Braumeister Ellipse

Create a model number by selecting from the options below:

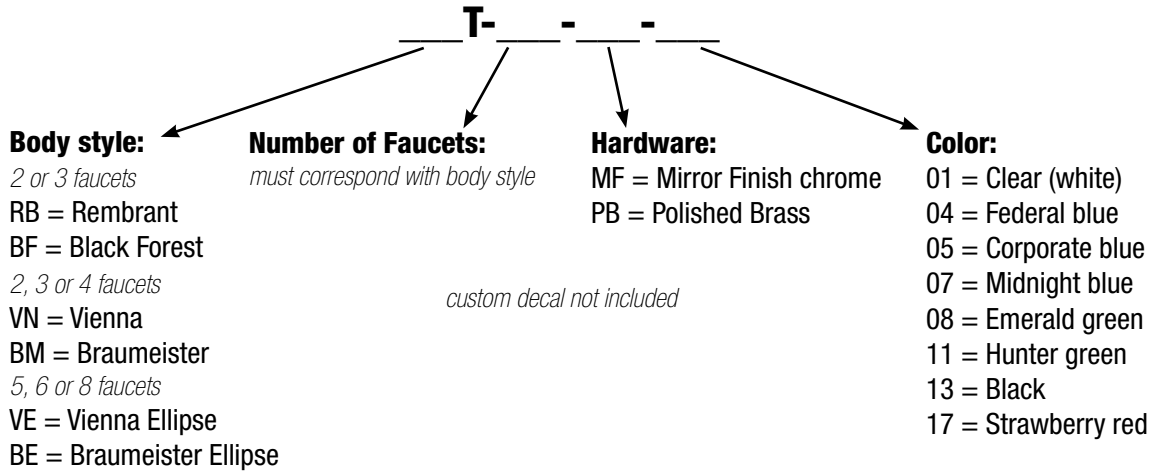

ZCT-5-PB-B

Zeus Ceramic Towers

ZCT- - -

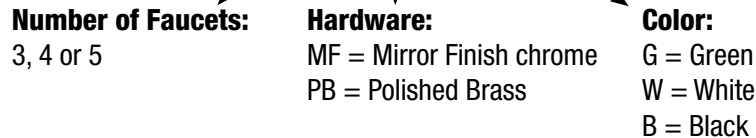

ZCT-5-MF-G



The following pictures are representations.
Actual appearance may vary.

Column Draft Beer Dispensing Towers

Cold beer is not only more satisfying, it has less foam and waste and yields greater profitability. Glycol helps maintain cold temperatures from the keg to the tap. All towers are NSF approved, have standard U.S. faucets and knobs, and come with mounting hardware, gasket and neoprene washer. Chrome towers are chrome plated brass.

The selection of dispensing towers is vast. If you don't find the style or configuration you're looking for, please call customer service for assistance.

Drip tray sizes shown in the tables are suggestions. More options can be found on page 14.



Snake tower



AXIS tower



Column tower

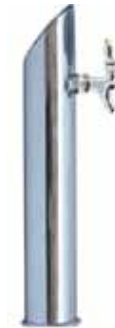

Tapered column tower



Column tower with pre-fitted tubing and beer nut

Part Number	Faucets	Finish	Cooling	Description	Drip Tray
C511	1	Chrome	Air	Snake tower, 11.75" H, brass shaft thread 1" through counter, product tube 3/16" ID x 7/16" OD	
C515	1	Chrome	Air	AXIS tower, faucet/knob brass insert, pre-fitted 3/16" ID x 5' long tubing with beer nut	
C530	1	Polished brass	Air	AXIS tower, faucet/knob brass insert, pre-fitted 3/16" ID x 5' long tubing with beer nut on one end	
4740K	1	Chrome	Air	Column tower, 2.5" wide, tap, knob, 5' long tubing, all hardware included	
4740KG	1	Chrome	Glycol	Column tower, 2.5" wide, tap, knob, 5' long tubing, all hardware included	
C512	1	Stainless steel	Air	Column tower, 3" wide x 18" H, taper cut tower for brand name display, faucet/knob brass insert, pre-fitted 3/16" ID x 5' long tubing, beer nut	
D4743T	1	Chrome	Air	Column tower, 3" wide, pre-fitted 3/16" ID x 5' long tubing, beer nut	
D4743TG	1	Chrome	Glycol	Column tower, 3" wide, pre-fitted 3/16" ID x 5' long tubing, beer nut	
C173	1	Stainless steel	Air	Column tower, 3" wide, pre-fitted 3/16" ID x 5' long tubing, beer nut	
C273	1	Stainless steel	Air	Column tower, 3" wide, 100% SS contact with beverage, pre-fitted 3/16" ID x 5' long tubing, beer nut, SS faucet, shank & tail piece	
D4743TBR	1	Polished brass	Air	Column tower, 3" wide, pre-fitted 3/16" ID x 5' long tubing, beer nut	8 x 5
D4743TBRG	1	Polished brass	Glycol	Column tower, 3" wide, pre-fitted 3/16" ID x 5' long tubing, beer nut	8 x 5
C513	1	Stainless steel	Air	Column tower, 3" wide, clamp on tower with drip tray, great for temporary use, no ABS & plastic parts, solid metal construction	Included



The following pictures are representations.
Actual appearance may vary.

Column and Mushroom Dispensing Towers

All towers are NSF approved, have standard U.S. faucets and knobs, and come with mounting hardware, gasket and neoprene washer. Chrome towers are chrome plated brass.

The selection of dispensing towers is vast. If you don't find the style or configuration you're looking for, please call customer service for assistance.



Part Number	Faucets	Finish	Cooling	Description	Drip Tray
C504	2	Stainless steel	Air	Column tower, 3" wide, clamp on tower with drip tray, great for temporary use, no ABS & plastic parts, solid metal construction	Included
D4743DT	2	Chrome	Air	Column tower, 3" wide, pre-fitted 3/16" ID x 5' long tubing, beer nut	8 x 5
D4743DTG	2	Chrome	Glycol	Column tower, 3" wide, pre-fitted 3/16" ID x 5' long tubing, beer nut	8 x 5
C175	2	Stainless steel	Air	Column tower, 3" wide, pre-fitted 3/16" ID x 5' long tubing, beer nut	8 x 5
C274	2	Stainless steel	Air	Column tower, 3" wide, 100% SS contact with beverage, pre-fitted 3/16" ID x 5' long tubing, beer nut, SS faucet, shank & tail piece	8 x 5
D4743DTBR	2	Polished brass	Air	Column tower, 3" wide, pre-fitted 3/16" ID x 5' long tubing, beer nut	8 x 5
D4743DTBRG	2	Polished brass	Glycol	Column tower, 3" wide, pre-fitted 3/16" ID x 5' long tubing, beer nut	8 x 5
C508	3	Stainless steel	Air	Column tower, 3" wide, pre-fitted 3/16" ID x 5' long tubing, beer nut	8 x 5
C275	3	Stainless steel	Air	Column tower, 3" wide, 100% SS contact with beverage, pre-fitted 3/16" ID x 5' long tubing, beer nut, SS faucet, shank & tail piece	8 x 5
C502	3	Polished brass	Air	Column tower, 3" wide, pre-fitted 3/16" ID x 5' long tubing, beer nut	8 x 5
D4743TTBRG	3	Polished brass	Glycol	Column tower, 3" wide, pre-fitted 3/16" ID x 5' long tubing, beer nut	8 x 5
C523	3	Chrome	Air	Column tower, 4" wide, concealed screw plate and decorative top cap, pre-fitted 3/16" ID x 5' long tubing, beer nut	8 x 5
MMT3SS	3	Chrome	Air	Mushroom tower, mini	
MMT3PB	3	Polished brass	Air	Mushroom tower, mini	
MMT4SS	4	Chrome	Air	Mushroom tower, mini	
MMT4PB	4	Polished brass	Air	Mushroom tower, mini	
WBCHMT4	4	Chrome	Air	Mushroom tower, large	WBMBDSS
WBBRMT4	4	Polished brass	Air	Mushroom tower, large	WBMBDBR
WBCHMT5	5	Chrome	Air	Mushroom tower, large	WBMBDSS
WBBRMT5	5	Polished brass	Air	Mushroom tower, large	WBMBDBR
WBCHMT6	6	Chrome	Air	Mushroom tower, large	WBMBDSS
WBBRMT6	6	Polished brass	Air	Mushroom tower, large	WBMBDBR



BAR EQUIPMENT



“T” and Pass-Thru Dispensing Towers

All towers have insulation, standard U.S. faucets and knobs, built-in collar and tail pieces, and come with mounting hardware, gasket, neoprene washer, and pre-fitted 3/16" ID x 5' long tubing with beer nut at the end.

For polished brass rather than stainless steel, replace “CR” or “SS” with “BR” in the part number.



Part Number	Faucets	Finish	Cooling	Description	Drip Tray
C509	3	Stainless steel	Air	T tower, 10-1/2" high, 3" wide pedestal, 9" wide box, pre-fitted 3/16" ID x 5' long tubing, beer nut	15 x 5
TT3CRG	3	Stainless steel	Glycol	T tower, 10-1/2" high, 3" wide pedestal, 9" wide box, pre-fitted 3/16" ID x 5' long tubing, beer nut	15 x 5
C510	4	Stainless steel	Air	T tower, 10-1/2" high, 3" wide pedestal, 13" wide box	15 x 5
C510	4	Stainless steel	Glycol	T tower, 10-1/2" high, 3" wide pedestal, 13" wide box	15 x 5
TT5CR	5	Stainless steel	Air	T tower, 10-1/2" high, 3" wide pedestal, 16" wide box	24 x 5
TT5CRG	5	Stainless steel	Glycol	T tower, 10-1/2" high, 3" wide pedestal, 16" wide box	24 x 5
TT6CR	6	Stainless steel	Air	T tower, 10-1/2" high, 3" wide pedestal, 19" wide box	24 x 5
TT6CRG	6	Stainless steel	Glycol	T tower, 10-1/2" high, 3" wide pedestal, 19" wide box	24 x 5
TTB6CR	6	Stainless steel	Air	T tower, 10-1/2" high, 4" wide pedestal, 19" wide box	24 x 5
TTB6CRG	6	Stainless steel	Glycol	T tower, 10-1/2" high, 4" wide pedestal, 19" wide box	24 x 5
TT8CR	8	Stainless steel	Air	T tower, 10-1/2" high, 3" wide pedestal, 25" wide box	30 x 5
TT8CRG	8	Stainless steel	Glycol	T tower, 10-1/2" high, 3" wide pedestal, 25" wide box	30 x 5
TTB8CR	8	Stainless steel	Air	T tower, 10-1/2" high, 4" wide pedestal, 25" wide box	30 x 5
TTB8CRG	8	Stainless steel	Glycol	T tower, 10-1/2" high, 4" wide pedestal, 25" wide box	30 x 5
PT6SS	6	Stainless steel	Air	Pass-thru tower, 10-1/2" H, (2) 3" wide pedestals, 19" box	24 x 5
PT6SSG	6	Stainless steel	Glycol	Pass-thru tower, 10-1/2" H, (2) 3" wide pedestals, 19" box	24 x 5
PT8SS	8	Stainless steel	Air	Pass-thru tower, 10-1/2" H, (2) 3" wide pedestals, 25" box	30 x 5
PT8SSG	8	Stainless steel	Glycol	Pass-thru tower, 10-1/2" H, (2) 3" wide pedestals, 25" box	30 x 5
PTB8SS	8	Stainless steel	Air	Pass-thru tower, 10-1/2" H, (2) 4" wide pedestals, 25" box	30 x 5
PTB8SSG	8	Stainless steel	Glycol	Pass-thru tower, 10-1/2" H, (2) 4" wide pedestals, 25" box	30 x 5
PT10SS	10	Stainless steel	Air	Pass-thru tower, 10-1/2" H, (2) 3" wide pedestals, 31" box	36 x 5
PT10SSG	10	Stainless steel	Glycol	Pass-thru tower, 10-1/2" H, (2) 3" wide pedestals, 31" box	36 x 5
PTB10SS	10	Stainless steel	Air	Pass-thru tower, 10-1/2" H, (2) 4" wide pedestals, 31" box	36 x 5
PTB10SSG	10	Stainless steel	Glycol	Pass-thru tower, 10-1/2" H, (2) 4" wide pedestals, 31" box	36 x 5
PT12SS	12	Stainless steel	Air	Pass-thru tower, 10-1/2" H, (2) 3" wide pedestals, 37" box	48 x 5
PT12SSG	12	Stainless steel	Glycol	Pass-thru tower, 10-1/2" H, (2) 3" wide pedestals, 37" box	48 x 5
PTB12SS	12	Stainless steel	Air	Pass-thru tower, 10-1/2" H, (2) 4" wide pedestals, 37" box	48 x 5
PTB12SSG	12	Stainless steel	Glycol	Pass-thru tower, 10-1/2" H, (2) 4" wide pedestals, 37" box	48 x 5



Under Bar and Wall Mount Dispensers

All dispensers have an attached drip tray. Air cooled under bar dispensers have a 3" OD brass tube 6" long attached to the bottom of the box for easy hook up to the flex pipe. Wall mount boxes are offset 1/2" from the top of the tray so when mounted the tray will be flush mounted to the wall.

8 and 10 faucet dispensers have 2 tubes for pass thru air flow. Box and drip tray are 16 gauge SS with attached 14 gauge SS bracket that wraps around and under the box. Faucets and 6' of tubing are included.

Part Number	Faucets	Finish	Cooling	Description	Drip Tray
UC4SS	4	Stainless steel	Air		None
UC5SS	5	Stainless steel	Air		None
UC6SS	6	Stainless steel	Air		None
UC8SS	8	Stainless steel	Air		None
UC9SS	9	Stainless steel	Air		None
UC10SS	10	Stainless steel	Air		None
UC11SS	11	Stainless steel	Air		None
UC12SS	12	Stainless steel	Air		None
UBD152	2	Stainless steel	Air	15" wide	Included
UBD152G	2	Stainless steel	Glycol	15" wide	Included
UBD153	3	Stainless steel	Air	15" wide	Included
UBD153G	3	Stainless steel	Glycol	15" wide	Included
UBD154	4	Stainless steel	Air	15" wide	Included
UBD154G	4	Stainless steel	Glycol	15" wide	Included
UBD245	5	Stainless steel	Air	24" wide	Included
UBD245G	5	Stainless steel	Glycol	24" wide	Included
UBD246	6	Stainless steel	Air	24" wide	Included
UBD246G	6	Stainless steel	Glycol	24" wide	Included
UBD308	8	Stainless steel	Air	30" wide	Included
UBD308G	8	Stainless steel	Glycol	30" wide	Included
UBD3610	10	Stainless steel	Air	36" wide	Included
UBD3610G	10	Stainless steel	Glycol	36" wide	Included
WMD152	2	Stainless steel	Air	15" wide	Included
WMD152G	2	Stainless steel	Glycol	15" wide	Included
WMD153	3	Stainless steel	Air	15" wide	Included
WMD153G	3	Stainless steel	Glycol	15" wide	Included
WMD154	4	Stainless steel	Air	15" wide	Included
WMD154G	4	Stainless steel	Glycol	15" wide	Included
WMD245	5	Stainless steel	Air	24" wide	Included
WMD245G	5	Stainless steel	Glycol	24" wide	Included
WMD246	6	Stainless steel	Air	24" wide	Included
WMD246G	6	Stainless steel	Glycol	24" wide	Included
WMD308	8	Stainless steel	Air	30" wide	Included
WMD308G	8	Stainless steel	Glycol	30" wide	Included
WMD3610	10	Stainless steel	Air	36" wide	Included
WMD3610G	10	Stainless steel	Glycol	36" wide	Included



For glycol ready, add "R" to the end of the part number. Wine faucets available.





Wunder-Bar Stainless One and Viper Towers

Stainless One towers are made of surgical stainless steel to prevent a metallic taste in the beer. Specially designed faucets prevent air from coming into contact with the valve cavity which is more sanitary than traditional faucets. The Stainless One eliminates line bounce, which is caused by the opening and closing of the faucet, which leads to increased foam in the keg. Towers include faucets. Surface mount drip trays include pan, grid and drain fittings.

Flooded Ice Viper towers produce a layer of frost on the tower for an extra chill thrill. Non-flooded Viper towers do not frost. All Viper towers are glycol ready and include faucets, all mounting hardware, fittings, and a 7' insulated tubing pigtail that includes one 3/16" ID restriction tube per brand and (2) 3/8" ID glycol coolant lines.

Part Number	Faucets	Finish	Cooling	Description	Drip Tray
75010400	1	Stainless steel	Air	Column tower, 100% SS construction	71001000
75020400	2	Stainless steel	Air	Column tower, 100% SS construction	71001000
75030400	3	Stainless steel	Air	Column tower, 100% SS construction	71001000
76041600	4	Stainless steel	Air	T tower, 100% SS construction	71001500
76051600	5	Stainless steel	Air	T tower, 100% SS construction	71002100
76061600	6	Stainless steel	Air	T tower, 100% SS construction	71002100
76071600	7	Stainless steel	Air	T tower, 100% SS construction	71002700
76081600	8	Stainless steel	Air	T tower, 100% SS construction	71002700
76101600	10	Stainless steel	Air	T tower, 100% SS construction	71003300
77101600	10	Stainless steel	Air	Pass-thru tower, 100% SS construction	71003300
77121600	12	Stainless steel	Air	Pass-thru tower, 100% SS construction	71003900
77141600	14	Stainless steel	Air	Pass-thru tower, 100% SS construction	71004500
WBVBT1C	1	Chrome	Glycol	Flooded Ice Viper tower	WBVBT1D
WBVBT1G	1	Gold	Glycol	Flooded Ice Viper tower	WBVBT1D
WBVBT2C	2	Chrome	Glycol	Flooded Ice Viper tower	WBVBT1D
WBVBT2G	2	Gold	Glycol	Flooded Ice Viper tower	WBVBT1D
WBVBT3C	3	Chrome	Glycol	Flooded Ice Viper tower	WBVBT3D
WBVBT3G	3	Gold	Glycol	Flooded Ice Viper tower	WBVBT3D
WBVBT4C	4	Chrome	Glycol	Flooded Ice Viper tower	WBVBT3D
WBVBT4G	4	Gold	Glycol	Flooded Ice Viper tower	WBVBT3D
WBVBT1CNF	1	Chrome	Glycol	Non-flooded Ice Viper tower	WBBDCH
WBVBT1GNF	1	Gold	Glycol	Non-flooded Ice Viper tower	WBBDCH
WBVBT2CNF	2	Chrome	Glycol	Non-flooded Ice Viper tower	WBBDCH
WBVBT2GNF	2	Gold	Glycol	Non-flooded Ice Viper tower	WBBDCH
WBVBT3CNF	3	Chrome	Glycol	Non-flooded Ice Viper tower	WBBDCH3
WBVBT3GNF	3	Gold	Glycol	Non-flooded Ice Viper tower	WBBDCH3
WBVBT4CNF	4	Chrome	Glycol	Non-flooded Ice Viper tower	WBBDCH3
WBVBT4GNF	4	Gold	Glycol	Non-flooded Ice Viper tower	WBBDCH3





Viper and Stainless One Drip Trays

Viper towers can be installed in a variety of configurations to achieve the desired look and number of brands poured. Drip tray (drainer) selection is dependent upon the style and configuration of tower(s). All Viper drip trays are stainless steel. Standard Viper drip trays have a grainline finish. Ice Viper drip trays have a mirror finish and are double drainers to handle the melting frost from the tower.



Part Number	Finish	Description
WBVBT1D	Mirror stainless steel	Double-drainer for (1) 1 or 2 faucet Ice Viper tower, 12" x 12"
WBVBT3D	Mirror stainless steel	Double-drainer for (1) 3 or 4 faucet Ice Viper tower, 18" x 12"
WBVBT1D2	Stainless steel	Drainer for (2) 1 faucet Ice Viper towers, 18" x 12"
WBVBT1D3	Stainless steel	Drainer for (3) 1 faucet Ice Viper towers, 18" x 12"
WBVBT2D2	Stainless steel	Drainer for (2) 2 faucet Ice Viper towers, 24" x 12"
WBVBT2D3	Stainless steel	Drainer for (3) 2 faucet Ice Viper towers, 24" x 12"
WBVBT3D2	Stainless steel	Drainer for (2) 3 faucet Ice Viper towers, 24" x 12"
WBVBT4D2	Stainless steel	Drainer for (2) 4 faucet Ice Viper towers, 30" x 12"
WBBDCH	Stainless steel	Drainer for 1 and 2 faucet non-flooded Viper towers
WBBDCH3	Stainless steel	Drainer for 3 and 4 faucet non-flooded Viper towers
71001000	Stainless steel	Curved recess for 1-3 faucet Stainless One column towers, 10" x 6"
71001001	Stainless steel	Surface mount drip tray for 2 and 3 faucet T towers, 10" x 6"
71001500	Stainless steel	Surface mount drip tray for 4 faucet T towers, 15" x 6"
71002100	Stainless steel	Surface mount drip tray for 5 and 6 faucet T towers, 21" x 6"
71002700	Stainless steel	Surface mount drip tray for 7 and 8 faucet T towers, 27" x 6"
71003300	Stainless steel	Surface mount drip tray for 10 faucet T and Pass-thru towers, 33" x 6"
71003900	Stainless steel	Surface mount drip tray for 12 faucet Pass-thru towers, 39" x 6"
71004500	Stainless steel	Surface mount drip tray for 14 faucet Pass-thru towers, 45" x 6"

Drain Fittings

Part Number	Description
C610	Standard drain nipple and nut, thread 1/2" BSP
C958	Standard drain assembly, 3-1/2" long, drain thread 5/8"x 18
C959	Standard drain assembly, 6" long, drain thread 5/8"x 18
C141	Standard drain assembly, 8" long, drain thread 5/8"x 18
C954	Drain assembly, 2" long, 1/2" MPT
C955	Drain assembly, 4" long, 1/2" MPT





BAR EQUIPMENT

Drip Trays

The drip trays shown below are the most popular. Other sizes, styles and finishes are available. If you don't find what you're looking for, please call customer service for assistance.



Flush mount



Surface mount



Column tower cut-out



Flange mount



Wall mount



Wall mount

Part Number	Size"	Finish	Drain	Description
C608	4 x 6	Stainless steel	No	Wall mount, stainless steel 304 solid 1.2 mm construction, 2" splash
C809	4 x 6	Stainless steel	Yes	Wall mount, stainless steel 304 solid 1.2 mm construction, 2" splash
C602	6 x 6	Stainless steel	No	Wall mount, stainless steel 304 solid 1.2 mm construction, 2" splash
C630	6 x 6	Stainless steel	Yes	Wall mount, stainless steel 304 solid 1.2 mm construction, 2" splash
C609	6 x 10	Brushed	No	Wall mount, stainless steel 304 solid 1.2 mm construction, 2" splash, black
C631	6 x 10	Brushed	Yes	Wall mount, stainless steel 304 solid 1.2 mm construction, 2" splash, black
C612	12 x 6	Stainless steel	No	Wall mount, stainless steel, 2" splash
C619	14 x 6	Stainless steel	No	Wall mount, stainless steel, 2" splash
C138	8 x 6	Stainless steel	Yes	Wall mount, stainless steel, 14" tall back splash, up to 3 holes with 3" spacing
DTWM15SS	15 x 6	Stainless steel	Yes	Wall mount, stainless steel, 14" tall back splash, up to 5 holes with 3" spacing
DTWM24SS	24 x 6	Stainless steel	Yes	Wall mount, stainless steel, 14" tall back splash, up to 3 holes with 3" spacing
DTWM30SS	30 x 6	Stainless steel	Yes	Wall mount, stainless steel, 14" tall back splash, up to 3 holes with 3" spacing
DTWM36SS	36 x 6	Stainless steel	Yes	Wall mount, stainless steel, 14" tall back splash, up to 3 holes with 3" spacing
C139	12 x 5	Brushed	Yes	Flush mount, stainless steel 304 construction
DTR15SS	15 x 5	Brushed	Yes	Flush mount, stainless steel 304 construction
DTR24SS	24 x 5	Brushed	Yes	Flush mount, stainless steel 304 construction
C611	6 x 5	Brushed	No	Surface mount, stainless steel 304 solid 1.2 mm construction
DT8SS	8 x 5	Stainless steel	Yes	Surface mount, SS 304 solid 1.2 mm construction, 3-1/2" drain assy. C 958
C613	12 x 5	Stainless steel	Yes	Surface mount, SS 304 solid 1.2 mm construction, 3-1/2" drain assy. C 958
DT15SS	15 x 5	Stainless steel	Yes	Surface mount, SS 304 solid 1.2 mm construction, 3-1/2" drain assy. C 958
C614	16 x 5	Stainless steel	Yes	Surface mount, SS 304 solid 1.2 mm construction, 3-1/2" drain assy. C 958
C615	18 x 5	Stainless steel	Yes	Surface mount, SS 304 solid 1.2 mm construction, 3-1/2" drain assy. C 958
C616	20 x 5	Stainless steel	Yes	Surface mount, SS 304 solid 1.2 mm construction, 3-1/2" drain assy. C 958
C617	24 x 5	Stainless steel	Yes	Surface mount, SS 304 solid 1.2 mm construction, 3-1/2" drain assy. C 958
C618	30 x 5	Stainless steel	Yes	Surface mount, SS 304 solid 1.2 mm construction, 3-1/2" drain assy. C 958
DT36SS	36 x 5	Stainless steel	Yes	Surface mount, SS 304 solid 1.2 mm construction, 3-1/2" drain assy. C 958
DT48SS	48 x 5	Stainless steel	Yes	Surface mount, SS 304 solid 1.2 mm construction, 3-1/2" drain assy. C 958
C606	12 x 5	Brushed	No	Surface mount, SS 304 solid 1.2 mm construction
C604	12 x 7	Brushed	No	Surface mount, 3/4" H, 5" x 2" cut-out for 3" column, stainless steel 1.6 mm
C605	12 x 7	Brushed	Yes	Surface mount, 3/4" H, 5" x 2" cut-out for 3" column, stainless steel 1.6 mm, includes 3-1/2" x 5/8" 18 threaded drain nipple with nut
C622	8-1/8	Stainless steel	Yes	Flange mount, stainless steel, plastic drain
C623	14-1/8	Stainless steel	Yes	Flange mount, stainless steel, plastic drain
C607	14 x 6	Stainless steel	No	Drip tray surface, stainless steel 304 solid 1.2 mm construction



BAR EQUIPMENT

Faucets, Handles and Accessories

Part #	Finish	Description
BF1002SS	Stainless steel	Faucet, std.
C117	Stainless steel	Faucet, self closing, SS lever
C283	Stainless steel	Faucet, creamer action (pull to open and push back for a foamy head), 100% SS
BF1001	Chrome	Faucet, std., brass lever
BF1002	Chrome	Faucet, std., SS lever
C211	Chrome	Faucet, self closing, brass lever
C204	Chrome	Faucet, US flow/foam control, 3.5" shank, knob, SS wall flange
C183	Chrome	Faucet, creamer action (pull to open and push back for a foamy head), SS shaft, brass lever
C205	Lacquered polished brass	Faucet, std., brass lever
C206	Lacquered polished brass	Faucet, std., SS lever
SF2000	Brass	Stout faucet
SF2001	Chrome	Stout faucet
C210	Chrome	Hand dispensing gun
C209	Stainless steel	Hand dispensing gun
C180	Stainless steel	Beer gun holder
C227	Stainless steel	Faucet spout extension, converts US faucet to European faucet spout, 8 mm internal diameter
C226	Chrome	Faucet spout extension
C182	Black	Faucet spout plug, controls fruit flies, yeast and bacteria when faucet is not in use
7010202	Stainless steel	Lever, std. beer faucet, 303 SS, thread 3/8" - 16 UNC
7010201	Brass	Lever, std. beer faucet, thread 3/8" - 16 UNC
4332	Chrome	Coupling nut for std. faucet
C184	Black plastic	Faucet handle, std., brass inserts, thread 3/8" - 16 UNC
4301	Black plastic	Faucet handle, std., no inserts, thread 3/8" - 16 UNC



Part #	Finish	Description
C185	Chrome	Faucet handle, std., chrome plated brass
C190	Chrome	Faucet extended handle, std., chrome plated brass
C120	Black plastic	Faucet knob ball, std.
C128	Chrome	2" faucet handle extension
C528	Chrome	1" faucet handle extension
C129	Chrome	Faucet handle angler/tilter, for vertical position handles
C829	Polished brass	Faucet handle angler/tilter, for vertical position handles
C680	Navy blue	Pub style handle
C681	White	Pub style handle
C682	Red	Pub style handle
C683	Black	Pub style handle
C684	Green	Pub style handle
C685	Yellow	Pub style handle
C690	Navy blue	Mini pub style handle
C691	White	Mini pub style handle
C692	Red	Mini pub style handle
C693	Black	Mini pub style handle
C694	Green	Mini pub style handle
C695	Yellow	Mini pub style handle
C241	Chrome	Finial, standard tap handle
C242	Polished brass	Finial, standard tap handle
C689	Chrome	Finial, top hat
C688	Polished brass	Finial, top hat
C243	Chrome	Ferrule, beer tap handle
C244	Polished brass	Ferrule, beer tap handle
C686	Chrome	Ferrule, large
C687	Polished brass	Ferrule, large
C130		Faucet plug, seals shank when faucet is removed, fits all beer & wine shanks
C109	Chrome	Adapter to connect faucet and quick disconnect



BAR EQUIPMENT

Diagram for C125 extra long shank assembly

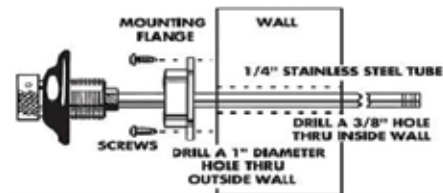

Shanks

Part #	Finish	Size"	Description
4331A	Chrome	2-1/8	Standard shank, 1/4" bore
4333A	Chrome	3-1/8	Standard shank, 1/4" bore
4334A	Chrome	4-1/8	Standard shank, 1/4" bore
4336A	Chrome	5-1/8	Standard shank, 1/4" bore
4337A	Chrome	6-1/8	Standard shank, 1/4" bore
4338A	Chrome	8-1/8	Standard shank, 1/4" bore
C212	SS	2	Standard shank, 1/4" bore
C213	SS	3-1/8	Standard shank, 1/4" bore
C214	SS	4-1/8	Standard shank, 1/4" bore
C234	SS	5-1/8	Standard shank, 1/4" bore
4331A3	Chrome	2-1/8	Std. shank, 3/16" bore
4333A3	Chrome	3-1/8	Std. shank, 3/16" bore
4334A3	Chrome	4-1/8	Std. shank, 3/16" bore
4336A3	Chrome	5-1/8	Std. shank, 3/16" bore
4337A3	Chrome	6-1/8	Std. shank, 3/16" bore
C318	Chrome	2-3/4	Nipple shank, 1/4" bore
4333NA	Chrome	3-1/2	Nipple shank, 1/4" bore
4334NA	Chrome	4-1/2	Nipple shank, 1/4" bore
4336NA	Chrome	5-1/2	Nipple shank, 1/4" bore
C300	Chrome	1-3/4	Nipple shank, 3/16" bore
C330	Chrome	2-3/4	Nipple shank, 3/16" bore
4331NA3	Chrome	2-1/2	Nipple shank, 3/16" bore
4333NA3	Chrome	3-1/2	Nipple shank, 3/16" bore
4334NA3	Chrome	4-1/2	Nipple shank, 3/16" bore
4336NA3	Chrome	5-1/2	Nipple shank, 3/16" bore
C125	Chrome	24	Extra long shank assy, 3/16" bore
C332	Chrome	1-7/8	Elbow nipple shank, 1/4"
C307	Chrome	2	Elbow nipple shank, 1/4"
C328	Chrome	1-7/8	Elbow nipple shank, 3/16"
C331	SS	1-7/8	Elbow nipple shank with TIG welded bend tube for SS faucets
C329	Pol. brs.	1-7/8	Elbow nipple shank, 3/16"
C126	Brass		Locking flange for wall shank assy
4346F	SS		Flange for std. shank
4346P	Plastic		Flange for std. shank

Part #	Finish	Description
C121	Chrome	Quick disconnect shank with auto shut mechanism
C122	Chrome	Quick disconnect nipple shank with plate
C702	SS	Quick disconnect beer tap connector
C228	Brass	Cold block, fits 7/8" shank

Tower Accessories

Part #	Finish	Description
C516	Chrome	Beer tower extension*, converts 1 faucet to 2
C520	Polished brass	Beer tower extension*, converts 1 faucet to 2
C517	Chrome	Beer tower extension*, converts 2 faucets to 3
C521	Polished brass	Beer tower extension*, converts 2 faucets to 3
C518	Chrome	Beer tower extension*, converts 1 faucet to 3
C522	Polished brass	Beer tower extension*, converts 1 faucet to 3
C507	Chrome	3" diameter tower cap for standard draft arm
C506	Polished brass	3" diameter tower cap for standard draft arm
C390	Chrome	Brass medallion for metal tower, chrome plated badge holder
C392	Gold	Brass medallion for metal tower, gold plated, badge holder
C500	Black	Clamp-on bracket for European style fonts
COT/B	Stainless steel	Clamp-on bracket, SS base, louvered grill, 1/2" hose adapter

Draft beer tower extensions include one column shank assembly, drill bit and screws.



Mark 4 Post-Mix Bar Guns

Wunder-Bar has improved their bar guns for ease of service and greater reliability. Going forward, all Wunder-Bar bar guns will have these new features.



- Locking hat plugs allow for service to one valve cavity at a time. Plugs stay put, even under pressure.
- Optional shut-off screw extensions allow the shut-off screws to be turned off/on with finger and thumb. Includes cover guard. Order with or without this feature.
- Manifold end of flex-hose assembly now include a welded stainless steel bushing, not plastic. Optional barrier tubing prevents flavor cross-over from pungent beverage syrups.
- Replace stem seal O-ring from the top of the handle, not the bottom, even under pressure. Retainer plate is removed, then O-ring.
- New shut-off screw include soft-tip for positive shut-off
- All handle heels now include split heel design.
- NEW Kwik Klip stays put. Won't pull out.
- Sanitary drip tray design catches any nozzle drip and provides sanitary air-gap from nozzle. Nozzle stays clean. New drip tray is NSF listed.



Cover guard removed



Cover guard in place



Old

New



10 button

12 button

14 button



Old

New





Mark 4 Bar Guns

The Wunder-Bar Mechanical Flex Hose bar dispenser is available in 1, 2, 3, 4, 5, 6, 7, 8, 9, 10, 12, and 14 button models. All models can be configured for many combinations of carbonated, non-carbonated, noncarbonated premix and energy drink products at any time. All of these combinations are field-convertible and can be modified without shutting off the dispenser. All seven, eight, and nine button dispensers have all the necessary valves and product tubes already installed into the dispenser, making the upgrade to up to ten buttons as easy as adding buttons on the handle and input modules and input fittings at the manifold.

Bar guns are available with permanent connections, quick disconnect or flow-regulated manifolds, optional barrier tubing, and in blue or red franchise colors. These units are field convertible from carbonated to non-carbonated and wine. Precision machined diffusers provide better carbonation, minimal brix stratification, faster flow rate and minimal foaming.

All Wunder-Bar post-mix type flexhose dispensers include two water meter adjustment screws which allow 2:1 ratio products to be brixed independently from 4:1 or 5:1 ratios. No more sacrificing flow rates to obtain a 2:1 brix!

Bar guns include quick disconnect manifold, SS input fittings, hose hanger and mounting hardware.

Buttons and Butterfly Plates

The buttons and button plate can be removed while the dispenser is under pressure. After the button plate has been removed, buttons can be changed as can the configuration of the dispenser. By removing the butterfly retainer and screws and lifting out the butterfly plates, various standard configurations and endless special configurations can be created. The butterfly plates' balls fit into indentations in the o-ring retainers located in the handle recess. The half moon cut out area of the butterfly plates are where the retainer and retainer screws are located when attaching the plates to the handle. When replacing butterfly plates, be careful not to over-tighten the retainer screws. Over-tightening the retainer screws can cause the butterfly plates to bind.

Butterfly plate configurations are detailed in the Replacement Parts section of this catalog.



Typical Post-Mix Bag-In-Box System

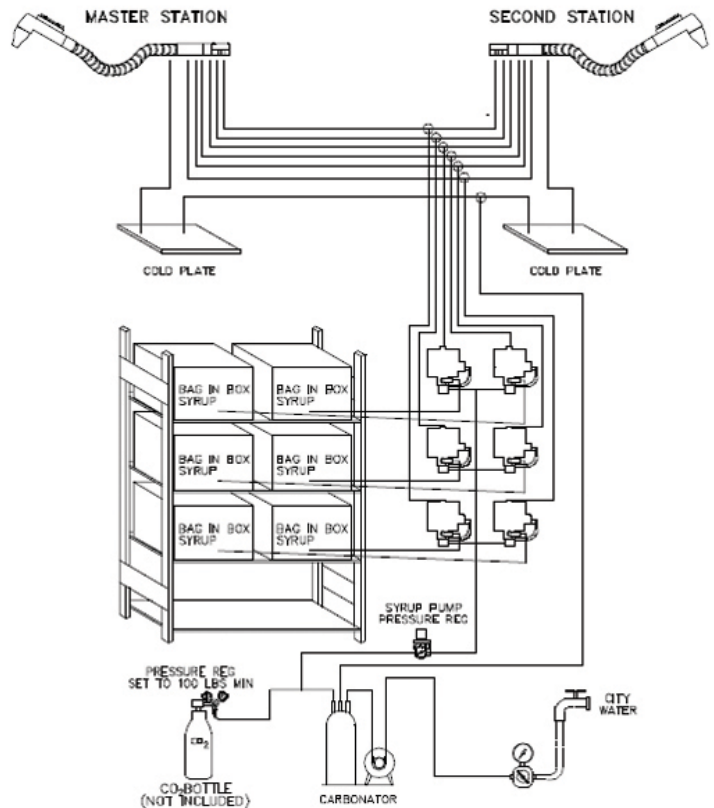



Mark 4 Bar Guns

MARK 4 dispenser model numbers will begin with the M4 designation. There will be no more dashes, unless the model includes NSF designation.

For example, an M410620KSM3 is a... MARK4, 10 button, 6 carbonated, 2 non carbonated, zero premix non carbonated, black(K), Series 2.5 (S), metering screw manifold (M), 3 ft. hose length.

The following charts explain model numbers. Underlined letters must be filled in with the desired options...

The model number will not be affected if shut off screw extensions are requested. Upon request they are included at no charge.

4 barrier lines are standard. Upon request 8 barrier lines are available at no cost, and are not part of the model number.

New dispensers ordered without instructions will include the new sanitary drip tray and hanger. However, old style drip cups and hangers are available upon request at no cost, and are not reflected in the model number.

Post-Mix and Energy Drink Dispensers Model Numbers									
M4	<u>a</u>	<u>b</u>	<u>c</u>	<u>d</u>	<u>e</u>	<u>f</u>	<u>g</u>	<u>h</u>	(-N)
Mark 4 dispenser	Total # of buttons (1-14)	Number of carbonated products	Number of non-carb products	Number of pre-mix non-carb products	Color: K = Black R = Red B = Blue G = Green C = Cabana blue	Type: S = std 2.5 2 = Series II 3 = Series III (large soda/ water tubing)	Manifold: M =metering screws F = flow reg. FM =flow reg + metering screws	Hose length: 3 = 3 ft. 4 = 4 ft. 5 = 5 ft. 6 = 6 ft.	Applies to NSF listed only (with plastic sheathing)

Post-Mix Juice Dispensers Model Numbers						
M4	<u>a</u>	JD	<u>e</u>	<u>f</u>	<u>h</u>	(-N)
Mark 4 dispenser	Total # of buttons (6-12)	Juice Dispenser	Color: K = Black R = Red B = Blue G = Green C = Cabana blue	Type: S = std 2.5 2 = Series II 3 = Series III (large soda/ water tubing)	Hose length: 3 = 3 ft. 4 = 4 ft. 5 = 5 ft. 6 = 6 ft.	Applies to NSF listed only (with plastic sheathing)

Wunder-Bar's Refurbishing Program

Wunder-Bar will refurbish post-mix dispensers within 8 years of original date of manufacture. To find and understand date codes, please contact your ABS representative. A \$20 credit/rebate toward the purchase of a new gun will be given for older guns.

Refurbishing includes a complete clean and strip, new tubing, new O-rings and any new parts required, including a complete handle assembly if necessary. Dispensers must be intact (include handle sheathing, hose, tube collector, manifolds, hanger kit, input fittings, etc.) Missing parts to make gun complete will be billed separately. Every gun is wet-checked prior to shipment from factory and carries an additional 1 year parts warranty.





Exploded view diagrams and parts lists can be found in the Replacement Parts section of this catalog.

Mark 4 Bar Guns

Please replace each asterisk (*) with the appropriate number or letter to configure a new Mark 4 bar gun. Be sure to **USE THE PROPER SEQUENCE** detailed on page 19, and outlined below.

Post-Mix	Quick Disconnect
M48****M*	8 button dispenser, 6 flavors, soda and water
M410****M*	10 button dispenser, 8 flavors, soda and water
M412****M*	12 button dispenser, 10 flavors, soda and water
M414****M*	14 button dispenser, 12 flavors, soda and water
**** Specify number of carbonated, non-carb, pre-mix, accent color, disp., manifold (M), and hose length. Example: M410620KSM3 = 10 button, 6 carbonated, 2 non-carbonated, 0 pre-mix, black (K), Series 2.5 (S), metering screw manifold (M), 3 ft. hose length	
Accent Colors: K=Black, R=Red, B=Blue, G=Green, C=Cabana Blue	
Dispenser type: S=Standard (2.5), 2=Series II, 3=Series III	
Manifold type: M=metering screws	
Hose lengths: 3=3' (standard). Optional (upcharge): 4=4', 5=5', and 6=6'	
If NSF listed (with plastic sheathing) is desired, add (N) to the end of the part number	
Post-Mix	Flow Regulator (F) / Flow Regulator+Metering Screws (FM)
M48****F*	8 button dispenser, 6 flavors, soda and water, flow regulator
M410****F*	10 button dispenser, 8 flavors, soda and water, flow regulator
M412****F*	12 button dispenser, 10 flavors, soda and water, flow regulator
M414****F*	14 button dispenser, 12 flavors, soda and water, flow regulator
M48****FM*	8 button dispenser, 6 flavors, soda and water, flow regulator+metering screws
M410****FM*	10 button dispenser, 8 flavors, soda and water, flow regulator+metering screws
M412****FM*	12 button dispenser, 10 flavors, soda and water, flow regulator+metering screws
M414****FM*	14 button dispenser, 12 flavors, soda and water, flow regulator+metering screws
**** Specify number of carbonated, non-carb, pre-mix, accent color, type, manifold (M), and hose length. Example: M410620KSF3 = 10 button, 6 carbonated, 2 non-carbonated, 0 pre-mix, black (K), Series 2.5 (S), flow reg manifold (F), 3 ft. hose length	
Accent Colors: K=Black, R=Red, B=Blue, G=Green, C=Cabana Blue	
Dispenser type: S=Standard (2.5), 2=Series II, 3=Series III	
Manifold type: F=Flow reg., FM=Flow reg+Metering screws	
Hose lengths: 3=3' (standard). Optional (upcharge): 4=4', 5=5', and 6=6'	
If NSF listed (with plastic sheathing) is desired, add (N) to the end of the part number	

Postmix



Energy drink



Juice



Premix



Minitower



Wine





Exploded view diagrams and parts lists can be found in the Replacement Parts section of this catalog.

WBM Bar Guns

Post-Mix	Quick Disconnect
WBM8****	8 button dispenser, 6 flavors, soda and water
WBM10****	10 button dispenser, 8 flavors, soda and water
WBM12****	12 button dispenser, 10 flavors, soda and water
WBM14****	14 button dispenser, 12 flavors, soda and water
**** Specify number of carbonated, non carbonated, pre-mix flavors and accent color. Example: WBM12640B; 12 button, 6 carbonated, 4 non-carbonated and 0 pre-mix flavors, blue accent	
Accent colors: Black (standard), R=Red, B=Blue	
Hose lengths - 36" standard. 48", 56", 60", 72" and 84" available optional upcharge	
Post-Mix	Flow Regulator
WBM8****FR	8 button dispenser, 6 flavors, soda and water
WBM10****FR	10 button dispenser, 8 flavors, soda and water
WBM12****FR	12 button dispenser, 10 flavors, soda and water
WBM14****FR	14 button dispenser, 12 flavors, soda and water
**** Specify number of carbonated, non carbonated, pre-mix flavors and accent color. Example: WBM12640RFR; 12 button, 6 carbonated, 4 non-carbonated and 0 pre-mix flavors, red accent	
Accent colors: Black (standard), R=Red, B=Blue	
Hose lengths - 36" standard. 48", 56", 60", 72" and 84" available optional upcharge	
Post-Mix	Mini Tower
WBM8***	8 button dispenser, 6 flavors, soda and water
WBM10***	10 button dispenser, 8 flavors, soda and water
WBM12***	12 button dispenser, 10 flavors, soda and water
WBM14***	14 button dispenser, 12 flavors, soda and water
****Specify number of carbonated, non carbonated, and pre-mix flavors. Example: WBM810530; 10 button, 5 carbonated, 3 non-carbonated and 0 pre-mix flavors	
Accent color - BLACK only	
Juice	Quick Disconnect
WBM6JD	6 button dispenser
WBM8JD	8 button dispenser
WBM10JD	10 button dispenser
WBM12JD	12 button dispenser
Accent color - BLACK only	
Hose lengths - 36" standard. 48", 56", 60", 72" and 84" available optional upcharge	
Juice	Mini Tower
WBM6JD	6 button dispenser
WBM8JD	8 button dispenser
WBM10JD	10 button dispenser
WBM12JD	12 button dispenser
Accent color - BLACK only	

Postmix



Energy drink



Juice



Premix



Minitower



Wine





Exploded view diagrams and parts lists can be found in the Replacement Parts section of this catalog.

WBM Bar Guns

Pre-Mix	Flex Hose
WBMPMX5	5 button dispenser
WBMPMX5S	5 button dispenser with ice shield
WBMPMX6	6 button dispenser
WBMPMX6S	6 button dispenser with ice shield
WBMPMX7	7 button dispenser
WBMPMX7S	7 button dispenser with ice shield
Accent colors: Black (standard), R=Red, B=Blue	
Hose lengths - 36" standard. 60", 72" and 84" available optional upcharge	
Wine	Flex Hose
WBM1WD	1 button dispenser
WBM2WD	2 button dispenser
WBM3WD	3 button dispenser
WBM4WD	4 button dispenser
Fast Flow	Flex Hose
WBM1PMFF	1 button fast flow dispenser postmix
WBM2PMFF	2 button fast flow dispenser postmix
WBM1PMXFF	1 button fast flow dispenser premix
WBM2PMXFF	2 button fast flow dispenser premix
Hose lengths - 36" standard. 48", 56", 60", 72" and 84" available optional upcharge	
Energy Drink	Flex Hose
WBM1**	1 button energy drink dispenser
WBM2**	2 button energy drink dispenser
WBM3**	3 button energy drink dispenser
WBM4**	4 button energy drink dispenser
**Specify number of carbonated and non carbonated flavors. Example: WBM110; 1 button, 1 carbonated, 0 non-carbonated	
Accent color - BLACK only	
Hose lengths - 36" standard. 48", 56", 60", 72" and 84" available optional upcharge	



Postmix



Energy drink



Juice



Premix



Minitower



Wine

WBM post-mix and energy drink dispensers come with 1/4" SS inlet fittings, and juice dispensers come with 3/8". Add an "S" to the end of the part number to include an ice/cold plate shield on a pre-mix dispenser. All fast flow dispensers are for non-carbonated products. Wine guns dispense bag-in-box wine. FR = flow regulated manifold. Four barrier lines per gun is standard. Other configurations are available.

Please contact your ABS representative if you don't find what you're seeking.



Bar Gun Accessories

Part Number	Description
PM1043	Hose hanger kit, complete
PH10119	Hose hanger kit, sanitary drip cup, complete
PM1074	Wire hose hanger kit, complete
PH10121	Wire hose hanger kit, sanitary drip cup, complete
Q722	Stainless steel custom drip tray
PM1044	Locking handle cover with lock
WBLB72	72" vendor lock bar
PMSA15	Waitress station
PMSA15CC	Waitress station, tall
PH1036	O-ring insert tool, brass
PM1073	Parts kit, series III and II.5
PM1038	Parts kit, series II
PM1099	90 degree manifold block, 10 brand
PM1299	90 degree manifold block, 12 brand
PM1499	90 degree manifold block, 14 brand



Bar Gun Round Snap-on Button Caps

Post-mix bar gun buttons (PH1074 Series) have two parts; the button (PH1073), and snap-on cap. Snap-on caps come in a variety of colors, letters and abbreviations.



Part Number	Imprint	Letter Color	Cap Color
PH1073	N/A	N/A	N/A
PH1074001	A	White	Green
PH1074002	B	White	Brown
PH1074003	B	Black	White
PH1074004	C	Black	White
PH1074005	C	White	Red
PH1074006	D	Black	White
PH1074007	F	Black	White
PH1074008	G	White	Green
PH1074009	G	Black	Pink
PH1074010	G	Black	White
PH1074011	I	Black	White
PH1074012	J	Black	White
PH1074013	L	Black	Yellow
PH1074014	L	White	Green
PH1074015	L	Black	Pink
PH1074016	L	Black	White
PH1074017	M	Black	White
PH1074018	O	Black	White

Part Number	Imprint	Letter Color	Cap Color
PH1074019	O	Black	Orange
PH1074020	P	Black	Yellow
PH1074021	P	Black	White
PH1074022	P	White	Brown
PH1074023	P	White	Purple
PH1074024	Q	Black	White
PH1074025	THROTL	White	Blue
PH1074026	R	White	Brown
PH1074027	R	White	Orange
PH1074028	R	Black	White
PH1074029	R	Black	Pink
PH1074030	R	Black	Orange
PH1074031	S	Black	White
PH1074032	S	Black	Yellow
PH1074033	T	White	Brown
PH1074034	T	White	Red
PH1074035	T	Black	White
PH1074036	V	Black	White



Bar Gun Round Snap-on Button Caps



Part Number	Imprint	Letter Color	Cap Color
PH1074037	W	Black	Pink
PH1074038	W	Black	White
PH1074039	X	Black	White
PH1074040	CR	White	Red
PH1074041	CR	White	Blue
PH1074042	DC	Black	White
PH1074043	DV	White	Black
PH1074044	GF	Black	Yellow
PH1074045	GF	Black	Pink
PH1074046	OJ	Black	Orange
PH1074047	RC	Black	White
PH1074048	RC	White	Blue
PH1074049	SQ	Black	White
PH1074050	SQ	Black	Yellow
PH1074051	SS	Black	White
PH1074052	SS	Black	Yellow
PH1074053	SS	White	Green
PH1074054	1	Black	White
PH1074055	2	Black	White
PH1074056	7UP	White	Green
PH1074057	EXTRACT	Black	Orange
PH1074058	APPLE	White	Green
PH1074059	BMARY	Black	White
PH1074060	BMARY	White	Brown
PH1074061	BMARY	White	Red
PH1074062	COLA	Black	White
PH1074063	COLA	White	Blue
PH1074064	COCO	Black	White
PH1074065	CHERRY	White	Red
PH1074066	COKE	White	Red
PH1074067	COLLINS	White	Black
PH1074068	CRAN	White	Red
PH1074069	DIET	White	Blue
PH1074070	DIET	White	Red
PH1074071	DIET	Blue	White
PH1074072	DIET	Red	White
PH1074073	DIET	Black	White
PH1074074	D PEP	White	Blue
PH1074075	D PEP	White	Brown
PH1074076	D PEP	White	Red
PH1074077	ONE	White	Blue

Part Number	Imprint	Letter Color	Cap Color
PH1074078	DR P	White	Brown
PH1074079	ADRN	Black	White
PH1074080	DR P	White	Red
PH1074081	DRY	Black	White
PH1074082	GALE	White	Green
PH1074083	GALE	Black	White
PH1074084	GINGER	White	Green
PH1074085	GINGER	Black	White
PH1074086	GRAPE	White	Purple
PH1074087	GATOR	Black	White
PH1074088	GUAVA	Black	Pink
PH1074089	RAVE	Black	Purple
PH1074090	GRPFT	Black	White
PH1074091	GRPFT	Black	Pink
PH1074092	GRPFT	Black	Yellow
PH1074093	GRPFT	White	Green
PH1074094	SUN TZU	Black	Yellow
PH1074095	GUAVA	Black	White
PH1074096	EXTRACT	Yellow	Black
PH1074097	ITAL	Black	White
PH1074098	KONDI	White	Green
PH1074099	LADE	Black	White
PH1074100	LADE	Black	Pink
PH1074101	LADE	Black	Yellow
PH1074102	LEMON	Black	White
PH1074103	LEMON	Black	Yellow
PH1074104	LEMON	Black	Pink
PH1074105	EXTRACT	Black	Pink
PH1074106	LIFT	Black	White
PH1074107	MANGO	Black	Orange
PH1074108	MAX	White	Blue
PH1074109	MIST	White	Green
PH1074110	MTDEW	Black	Yellow
PH1074111	MTDEW	White	Green
PH1074112	D 7UP	White	Green
PH1074113	ONE	White	Blue
PH1074114	ORG	Black	Orange
PH1074115	ORG	Black	White
PH1074116	(blank)	(blank)	Orange
PH1074117	PAPAYA	White	Purple
PH1074118	PASS	White	Purple



BAR EQUIPMENT

Wunder-Bar NSF

Bar Gun Round Snap-on Button Caps



PH1076 button



PH1077500, snap-on oval cap



PH1077501, snap-on oval cap

Part Number	Imprint	Letter Color	Cap Color
PH1074119	PEACH	Black	Orange
PH1074120	PEACH	Black	Pink
PH1074121	PEACH	Black	White
PH1074122	PIBB	White	Brown
PH1074123	PEPSI	White	Blue
PH1074124	PEPSI	White	Green
PH1074125	PEPSI	Black	White
PH1074126	PINA	Black	White
PH1074127	PINE	Black	Yellow
PH1074128	PINE	Black	White
PH1074129	POG	White	Purple
PH1074130	PRUNE	White	Brown
PH1074131	PRUNE	Black	White
PH1074132	PUNCH	White	Red
PH1074133	PUNCH	Black	Pink
PH1074134	PUNCH	Black	White
PH1074135	RASP	White	Red
PH1074136	RASP	Black	White
PH1074137	RASP	Black	Pink
PH1074138	RBEER	Black	White
PH1074139	RBEER	White	Brown
PH1074140	RED	White	Red
PH1074141	ROSE	Black	Pink
PH1074142	SLICE	Black	White
PH1074143	SLICE	Black	Orange
PH1074144	SLICE	White	Green
PH1074145	SOUR	Black	White
PH1074146	SOUR	Black	Yellow
PH1074147	SOUR	White	Green
PH1074148	SPRITE	White	Green
PH1074149	STORM	White	Green
PH1074150	SQUIRT	White	Green
PH1074151	STRAW	White	Red
PH1074152	STRAW	Black	Pink
PH1074153	STRAW	Black	White
PH1074154	(blank)	(blank)	Blue
PH1074155	SQUIRT	Black	White
PH1074156	SQUIRT	Black	Yellow
PH1074157	TEA	Black	White
PH1074158	TEA	White	Red
PH1074159	TEA	White	Brown

Part Number	Imprint	Letter Color	Cap Color
PH1074160	TOM	White	Red
PH1074161	TONIC	Black	White
PH1074162	WHITE	Black	White
PH1074163	SS	Black	Green
PH1074164	LION	Black	Yellow
PH1074165	BULL	White	Black
PH1074166	LION HEAD	Black picture	Yellow
PH1074167	SOBE	Black	Yellow
PH1074168	* (star)	Black	Yellow
PH1074169	TANGO	Black	Orange
PH1074170	ENERGY	Black	White
PH1074171	(blank)	(blank)	Brown
PH1074172	FUEL	White	Red
PH1074173	SPORT	Black	Yellow
PH1074174	SPORT	White	Red
PH1074175	SPORT	Black	Green
PH1074176	BONZAI	Yellow	Red
PH1074177	BONZAI	White	Blue
PH1074178	ZERO	Blue	White
PH1074179	TR	Black	Yellow
PH1074180	TSF	Black	Yellow
PH1074181	BL	White	Blue
PH1074182	POWER	White	Blue
PH1074183	POWER	White	Red
PH1074184	POWER	Black	White
PH1074185	RUSH	White	Red
PH1074186	(blank)	(blank)	Green
PH1074187	(blank)	(blank)	Pink
PH1074188	(blank)	(blank)	Purple
PH1074189	(blank)	(blank)	Red
PH1074190	(blank)	(blank)	Yellow
PH1074191	S	White	Green
PH1074192	(blank)	(blank)	White
PH1074193	D 7UP	Green	White
PH1074194	ENERGY	Black	White
PH1077500	SODA	Black	White
PH1077501	WATER	Black	White
PH1077502	CARB	Black	White
PH1077503	(blank)	(blank)	White



Cyclone (Portion Control) and Reserve Bottle System for Liquor Management

The Wunder-Bar Cyclone and Reserve Bottle system provides fast, accurate and consistent drink portion sizes every time, eliminates waste, provides accountability, and yields higher profits!

Your bartenders can “show” a free pour that is really tightly controlled and measured. Using the pour spout and Cyclone collar, the system knows what brand is being poured, what amount, and what bartender poured it. You set the pour size, you allow or don’t allow over pours or complimentary pours, and best of all, you control profit.

The Cyclone system can also be programmed to automatically turn on or off or go into/out of “Happy Hour Special Modes”. Pre-positioned Cyclone pour spouts means less time replacing empties at the bar, and stops theft. The system is also tamper proof with seals that show when a spout has been removed.

Pre-program your multiple ingredient “cocktail” drinks into the system and dispense up to six different liquor flavors simultaneously, quickly and accurately. In addition, these over/under and “cocktail” pours are recorded by station and shift as part of your beverage management report.

Low level liquor sensors on the rack detect when your liquor supply has run low and stops the system from pouring. This eliminates short pours, improperly mixed “cocktail” recipes and keeps the liquor lines primed.

The Wunder-Bar Cyclone system can be used in conjunction with the System III Liquor flexhose liquor dispensing systems which provides as many as 16 different brands, ready to pour in fast pre-measured amounts.

Basic level unit tracks 1-15 brands of liquor with 4 pour sizes and reports total sales on the processor’s display panel.

Medium level unit tracks up to 150 brands of liquor with 4 pour sizes in two price levels. Reports total sales to remote printer, and interface ready to access most P.O.S. systems.

Top level unit tracks up to 150 brands of liquor with 4 pour sizes in two price levels. System networks up to 30 stations to your computer for comprehensive reporting and is interface-ready for most P.O.S. systems.

Reserve Racks, left to right:
mini, medium and large



Control portions, track usage, improve profits



Fast, accurate and consistent portions



Beverage management reports



Top-Fill Automatic Frozen Specialty Drink Maker

This system eliminates the need to hand-mix the ingredients prior to pouring into the top of your frozen drink machine, dispenses 1 to 6 ingredients simultaneously, and assures accurate mixtures which means consistently good-tasting beverages.

The Wunder-Bar Top Fill dispensing system head monitors the level in your drink maker's freezer bath and automatically refills the bath as needed. Liquor ingredients are dispensed from the Wunder-Bar liquor storage rack. Total bottle capacity may vary with your particular requirements. Post-mix syrup, margarita for example, is blended with the proper ratio of water to provide fresh and properly formulated, finished-mix margarita beverage. Daiquiri, piña colada, virgin margaritas and many other specialty drinks can be dispensed to YOUR recipe.

The Top Fill dispensing head retrofits to existing systems already in use. It includes a sophisticated level-monitoring device that automatically refills the freezer bath when product is drawn off by the bartender. If the system runs out of one or more ingredients, sensors will determine this and the system turns off to be sure that you do not dispense an improper mixture into the freezer tank. Additionally, a signal light turns on to warn the operator to check liquor or syrup supplies in the storage area.



Wunder-Bar Top Fill dispensing system



Wunder-Bar liquor storage rack

Cold Plates

Cold plates are placed in an ice bin. Ice chills the cold plate which chills beverages as they pass through the circuits in the cold plate before being dispensed by a bar gun. All cold plates include 5/16" MFL x 1/4" barbed fittings for each circuit, and can be special ordered with different fittings.

Part Number	Description
10X15-1	1 circuit cold plate
10X15-2	2 circuit cold plate
10X15-3	3 circuit cold plate
10X15-4	4 circuit cold plate
10X15-5POST	5 circuit cold plate, post-mix
10X15-5PRE	5 circuit cold plate, pre-mix
10X15-6POST	6 circuit cold plate, post-mix
10X15-7	7 circuit cold plate
10X15-8	8 circuit cold plate
3016	Cold plate fitting OUT to shank assy, SS, 1/2"-16 threads, 3/16" ID bore
3018	Cold plate fitting IN from coupler, SS, 3/8" OD barb



3016
3018



BAR EQUIPMENT

Beer Couplers/Taps

Coupling heads can be used for single or series keg dispensing on single valve kegs. Picnic taps are for use with 4" hand pumps. Replacement parts are available.



Picnic Pumps



Part #	Description
CH5000	Coupler, blue handle
CH5001	Coupler, red handle
CH5002	Coupler, black handle
CH5000SS	Coupler, stainless steel, gray handle
CH500045L	Lever tap with Kam-Loc barrel for US kegs
CH5100L	Lever Tap with Kam-Loc barrel lock for Euro- pean kegs
CH5100	European coupler, black handle
CH5200G	European G coupler, DSI (Bass)
CH5300U	European U coupler DSI (Guinness/Harp)
CH5400A	European A coupler DSI (Warensteiner/Pa)
FT86	Am. Sankey fast tap with metal wing handle
FT86P	Am. Sankey fast tap with plastic wing handle
FT90	Euro single valve tap with metal wing handle
FT90P	Euro single valve tap with plastic wing handle
FT37	Picnic tap with plastic wing handle
FT37M	Picnic tap with metal wing handle
FT50	Picnic tap with metal and plastic lever handle
FT44T	Low profile tap with threaded nipple
C701	U.S. Sankey couple, D style, SS, nickel probe
C703	U.S. Sankey couple, D style, SS body & probe
C705	Euro Sankey couple, D style, SS, nickel probe
C704	Euro Sankey couple, D style, SS body & probe

Part #	Description
PP501	Pony pump, American
PP601	Bronco pump, American
PP6014	Bronco pump with 4 faucets, American
PP602	Bronco pump, European
C393	Chrome plated brass 4" metal pump, no plastic
C394	Chrome plated brass 8" metal pump, no plastic
FT37PF	8" cylinder hand pump, wing tap, faucet/hose
FT50PF	8" cylinder hand pump, handle tap, faucet/hose
C383	Upright convertor assy, 4" metal pump, faucet, knob, all metal parts, (no coupler)
C384	Upright convertor assy, 8" metal pump, faucet, knob, all metal parts, (no coupler)
C150	12" upright dispensing rod, no tap or knob
70502	Faucet, plastic
C397	Vertical pump adapter, pump screws on top, coupler on bottom, air and beer line on sides
C151	Clamp set, holds picnic pump to upright rod
C396	Connector, picnic pump to CO ₂ inlet of coupler
C399	Sankey pump adapter, chrome



Beer and Wine Pumps and FOB Stops

Whether installed on a long or short draw system, beer pumps are a cost effective means of moving beer. They also increase the pressure in the product line which prevents the gas in the beer from breaking out, thus preserving the quality of the drink.



G561202E

16625716

FSP0002A

LF521402



Flow reversal valve fits a Flojet G56 beer pump allowing beer line cleaners to run cleaning solution in both directions. Running solution in alternating directions enhances cleaning efficiency.

FRV0001A



215531B

9421116

A FOB-Stop prevents unwanted foam when a new keg is tapped, and keeps the line primed when the keg empties. It eliminates waste, provides better beer presentation, reduces microbiological contamination, and saves time in keg changes. The FOB-Stop can be mounted directly on a keg coupler or on a wall mount bracket.

Part Number	Description
G561202E	Flojet air/CO ₂ driven beer pump, straight outlet, 5 gpm flow rate, ave. lifetime 70,000 gallons
G561162	Flojet air/CO ₂ driven beer pump, elbow outlet, 5 gpm flow rate, ave. lifetime 70,000 gallons
16625716	Shurflo Beer Ace II, air/CO ₂ driven beer pump, ave. lifetime 35,000 gallons
FSP0002A	Flojet beer and wine bag-in-box pump, electric, If inlet exceeds 30 PSI pump requires 30 PSI water pressure regulator
LF521402	Flojet high speed motor, electric, 40 psi switch
LF521002	Flojet high speed motor, electric, no switch
LF521B02	Flojet high speed motor, electric, 40 psi switch, comes with 3/8" (9.5 mm) John Guest port fitting
FRV0001A	Flow reversal valve
215531B	Taprite Cellarbouy II foam detection system (FOB)
9421116	Shurflo FOB



BAR EQUIPMENT

Beer Chillers



Part #	Description
C801	Jockey box coil cooler, 1 faucet, 50' SS coil, 28 qt. ice box, insulated, faucet, knob, 5' hose assy. to coupler
C149	Jockey box coil cooler, 2 faucet, 50' SS coil, 28 qt. ice box, insulated, faucet, knob, 5' hose assy. to coupler
C640	Jockey box drip tray with drain, SS, 6" x 6"
C301S	Special shank for Jockey Box, 3" long, 1/4" bore x 5/16" bore
C220	Stainless steel 50' cooling coil, 5/16" OD, beer nuts and ferrules
C250	Stainless steel 90' cooling coil, 3/8" OD, grommets, nuts, ferrules to connect to shank
C224	Stainless steel 120' cooling coil, 3/8" OD, grommets, nuts, ferrules to connect to shank
C219	Standard wort chiller with garden hose fittings, 25' copper coil, 3/8" OD
C131	Wall coupling for coil cooler, 3/8" bore
C132	Wall coupling for coil cooler, 5/16" bore
C106	Grommet for stainless steel cooling, 1/4" ID
C107	Grommet for stainless steel cooling, 5/16" ID
C108	Grommet for stainless steel cooling, 3/8" ID
C207	Chrome ferrule for SS cooling, 1/4" ID
C208	Chrome ferrule for SS cooling, 5/16" ID
C216	Chrome ferrule for SS cooling, 3/8" ID
DD10	Refrigerator conversion kit #1
DD10L	Refrigerator conversion kit #2

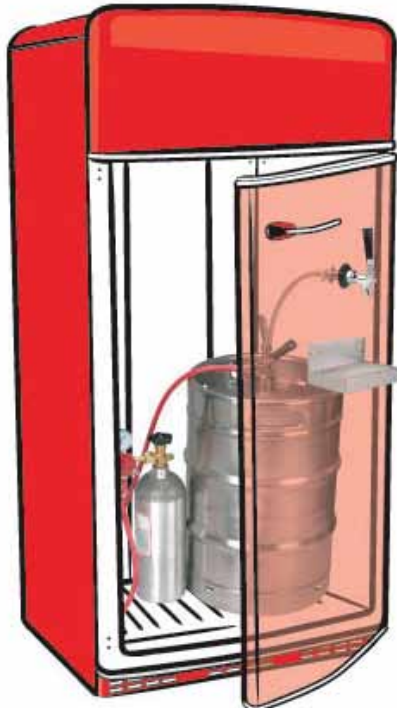

Save time and money with a Taprite Keg Beer Refrigerator Conversion Kit!

KIT-1 includes:

- Taprite double gauge regulator
- 5 lb. CO₂ cylinder (empty)
- Air line with clamps
- Beer line
- Spacer
- Beer faucet with shank
- Stainless steel drip tray with tray insert and holder
- "D" style keg coupler
- Keg tap
- Faucet wrench
- Installation instructions

KIT-2 Includes:

- Everything above excluding CO₂ cylinder





Glycol Chiller Recirculating Units

Complete with adjustable temperature control, recirculating motor and pump. Please inquire for job-specific VIPER Tower and conduit length specifications. 115V unless noted.



Part Number	HP	Pumps	Conduit	Gal. Bath	Dimensions"	Add'l Info
LFMSGLY	1/5	1	50'	6	12.5W x 23.4D x 23.4H	
SCRGLY	1/3	1	125'	9	26.4W x 15.75D x 29.25H	
SCRGLYD	1/3	2	125'	9	26.4W x 15.75D x 29.25H	
SCR1/2GLY	1/2	1	125'	9	26.4W x 15.75D x 29.25H	
SCR1/2GLYD	1/2	2	125'	9	26.4W x 15.75D x 29.25H	
VLMGLY	1/2	1	250'	22.5	44.6W x 24.5D x 22H	
VLMGLYD	1/2	2	250'	22.5	44.6W x 24.5D x 22H	
VLM3/4GLY	3/4	1	350'	22.5	44.6W x 24.5D x 22H	
VLM3/4GLYD	3/4	2	350'	22.5	44.6W x 24.5D x 22H	
VAC1GLY	1	1	500'	22.5	44.6W x 24.5D x 22H	208/230V
VAC1GLYD	1	2	500'	22.5	44.6W x 24.5D x 22H	208/230V
VAC1GLYT	1	3	500'	22.5	44.6W x 24.5D x 22H	208/230V
VAC1GLYQ	1	4	500'	22.5	44.6W x 24.5D x 22H	208/230V
HLMGLY	1/2	1	250'	22.5	36.4W x 24.6D x 29.2H	
HLMGLYD	1/2	2	250'	22.5	36.4W x 24.6D x 29.2H	
HLM3/4GLY	3/4	1	350'	22.5	36.4W x 24.6D x 29.2H	
HLM3/4GLYD	3/4	2	350'	22.5	36.4W x 24.6D x 29.2H	
HAC1GLY	1	1	500'	22.5	36.4W x 24.6D x 29.2H	208/230V
HAC1GLYD	1	2	500'	22.5	36.4W x 24.6D x 29.2H	208/230V
HAC1GLYT	1	3	500'	22.5	36.4W x 24.6D x 29.2H	208/230V
HAC1GLYQ	1	4	500'	22.5	36.4W x 24.6D x 29.2H	208/230V
WBBB3001	1/3	1	175'	6	26W x 15.2D x 26H	Beer Boss
WBBB5001	1/2	1	250'	6	26W x 15.2D x 26H	Beer Boss
WBBB5002	1/2	2	250'	6	26W x 15.2D x 26H	Beer Boss
WBBB7501	3/4	1	350'	10	34.2W x 20D x 29.5H	Beer Boss
WBBB7502	3/4	2	350'	10	34.2W x 20D x 29.5H	Beer Boss
WBBB10001	1	1	500'	10	34.2W x 20D x 29.5H	Beer Boss
WBBB10002	1	2	500'	10	34.2W x 20D x 29.5H	Beer Boss
WBBB10003	1	3	500'	10	34.2W x 20D x 29.5H	Beer Boss
WBBB10004	1	4	500'	10	34.2W x 20D x 29.5H	Beer Boss
WBBB15001	1-1/2	1	1000'	10	34.2W x 20D x 29.5H	Beer Boss
WBBB15002	1-1/2	2	1000'	10	34.2W x 20D x 29.5H	Beer Boss
WBBB15003	1-1/2	3	1000'	10	34.2W x 20D x 29.5H	Beer Boss
WBBB15004	1-1/2	4	1000'	10	34.2W x 20D x 29.5H	Beer Boss
WBBBLP3001	1/3	1	175'	6	22.75W x 24.25D x 15H	Beer Boss, LP
WBBBLP3002	1/3	2	175'	6	22.75W x 24.25D x 15H	Beer Boss, LP
WBBBLP5001	1/2	1	250'	6	22.75W x 24.25D x 15H	Beer Boss, LP
WBBBLP5002	1/2	2	250'	6	22.75W x 24.25D x 15H	Beer Boss, LP
WBBBLP7501	3/4	1	350'	10	38W x 27D x 17.5H	Beer Boss, LP
WBBBLP7502	3/4	2	350'	10	38W x 27D x 17.5H	Beer Boss, LP
WBBBLP10001	1	1	500'	10	38W x 27D x 17.5H	Beer Boss, LP
WBBBLP10002	1	2	500'	10	38W x 27D x 17.5H	Beer Boss, LP
WBBBLP10003	1	3	500'	10	38W x 27D x 17.5H	Beer Boss, LP
WBBBLP10004	1	4	500'	10	38W x 27D x 17.5H	Beer Boss, LP

Photographs below are representations. Actual appearance may differ.



WBBBWS300
wall mounting stand for 1/3 and 1/2 HP Beer Boss chillers

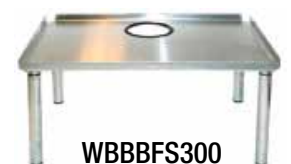

WBBBFS300
floor stand for 1/3 and 1/2 HP Beer Boss chillers
WBBBFS750
floor stand for 3/4 and 1 HP Beer Boss chillers



Glycol Chiller Recirculating Units

More details available. Please visit www.glastender.com

Remote chillers are sized to handle different length runs. If two separate conduits are involved, then the lengths of the two runs must be added together to determine the total run requirement. The run length is calculated as the distance between the line chiller and the beer tower in a single pass glycol conduit, including any rise or fall.

A remote installable control panel allows the glycol bath and recirculating pump(s) to be installed separately from the condensing unit in a more convenient location. Simply remove the control panel from the condensing unit cabinet and mount

it in the desired location. Only glycol and electrical lines need to be run between the control panel and the condensing unit cabinet.

The chiller stand is 26.5" wide x 39" high x 24" deep and comes with adjustable feet for leveling. The bottom shelf is 8" high. The top shelf has holes that correspond to the line chiller leg set, so the chiller can be bolted to the shelf. One size stand is used for all line chiller models. Similarly, the line chiller wall rack has holes that correspond to the leg set so the unit can be bolted to the shelf.



BLC1/32

Part #	HP	Pumps	Conduit	Gal. Bath	Dimensions"	Add'l Info
BLC1/3E	1/3	1	125'	.94	21.25W x 27D x 14.75H	
BLC1/3	1/3	1	125'	.94	25.63W x 27D x 16H	Remote capable
BLC1/32	1/3	2	125'	.94	25.63W x 27D x 16H	Remote capable
BLC1/2	1/2	1	250'	.94	25.63W x 27D x 16H	Remote capable
BLC1/22	1/2	2	250'	.94	25.63W x 27D x 16H	Remote capable
BLC3/4	3/4	1	400'	.94	25.63W x 27D x 16H	Remote capable
BLC3/42	3/4	2	400'	.94	25.63W x 27D x 16H	Remote capable



LCSG



LCRS



LCRG

Part #	Description
LCSS	Line chiller stand, 16 gauge SS
LCSG	Line chiller stand, 16 gauge galvanized
LCRSE	Wall rack for BLC1/3E, SS
LCRGE	Wall rack for BLC1/3E, galvanized
LCRS	Wall rack for all models except BLC1/3E, SS
LCRG	Wall rack for all models except BLC1/3E, galv
CE220/50S	220V, 1 phase, 50 Hz electrical

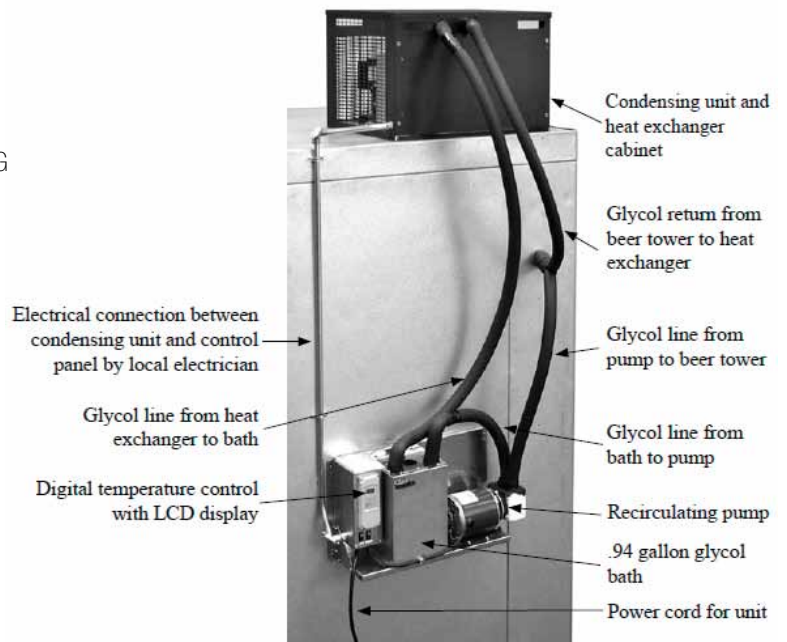



BAR EQUIPMENT

Propylene Glycol

Propylene glycol is a colorless, odorless, biodegradable heat transfer liquid commonly used as an anti-freeze or coolant. The products on this page are non-toxic, food quality (not food grade*) and can be used in chillers, refrigeration and other mechanical systems where food is processed, but not where it will come in direct contact with food.

*Food grade propylene glycol is used as a direct food additive in some cosmetics, fragrances, sunscreens, shampoos and pharmaceuticals.



Part #	Description	% Glycol	Corrosion Inhibitor	Color Additive	Gallons	Units Per Carton
35714	Profrost	100%	No	No	5	1
35715	Profrost	100%	No	No	55	1
35720	Profrost - I	100%	Yes	No	5	1
35721	Profrost - I	100%	Yes	No	55	1
35723	Profrost - Cl	100%	Yes	Yes	5	1
35722	Profrost - Cl	100%	Yes	Yes	55	1
35760	Freeze Safe Valuline	80%	Yes	Yes	1	4
35761	Freeze Safe Valuline	80%	Yes	Yes	5	1
35762	Freeze Safe Valuline	80%	Yes	Yes	55	1
35711	PG Food Quality	40%	Yes	No	5	1
35712	PG Food Quality	40%	Yes	No	55	1

CO₂ Purifier

Prevents off-tastes and aromas from spoiling draft beer due to CO₂ cylinders that may not have been properly cleaned before re-filling. By placing a CO₂ purifier in the system, contaminants are removed to ensure optimum results.

For best results install in an upright position and replace after 12 months of use. Use 954-1B quick disconnects and 11048 mounting brackets (sold separately). 125 psi max. pressure. Dimensions: 12-1/2" L x 2-5/8" diameter.

Part Number	Description
770SGL1300	In-line CO ₂ purifier
9541B	Quick disconnects
11048	Mounting brackets



770SGL1300



BAR EQUIPMENT



CO₂ Cylinders and Parts

Catalina seamless aluminum alloy compressed gas cylinders are manufactured in accordance with U.S. DOT 3AL and TC 3ALM requirements and are stamped with required U.S. Department of Transportation (DOT) and Transport Canada (TC) Markings. Every cylinder is inspected and tested by a DOT and TC authorized independent inspection agency. Service pressure: 1800 psi / 124 bar.



Part Number	Description
B5	5 lb. / 2.3 kgs. cylinder, Catalina
B10	10 lb. / 4.5 kgs. cylinder, Catalina
B20	20 lb. / 9.1 kgs. cylinder, Catalina
B35	35 lb. / 15.9 kgs. cylinder, Catalina
CGA320	Replacement valve**
H1	Carrying handle, Catalina*
H2	Carrying handle, Luxfer*
SR1	Snap ring, Catalina
SR2	Snap ring, Luxfer
NU23	CO ₂ warning tags, 1000/box
J1/2	CO ₂ threaded blue cap plug

* Please specify handle color: black, red or blue

** Replacement parts and breakdowns are available on website



Carrying handle



C261 CO₂ wrench



CO₂ Cylinder Accessories

Part #	Description	Dimensions"
RC1	Restraining chain for CO ₂ cylinders	
CH220	Cylinder restraint for two 20 lb. cylinders	17" W x 17" H x 8.75" D
CH5020	Cylinder restraint for two 20 or 50 lb. cylinders	21" W x 4" H x 10.38" D
3350	Storage rack for 50 lb. cylinders, 3 x 3 pallet	38.5" W x 35" H x 36" D
3450	Storage rack for 50 lb. cylinders, 3 x 4 pallet	48" W x 35" H x 36" D
NS4	Replacement nylon strap for storage rack	
3320	Stack/store rack for sixteen 20 lb. cylinders, 3 x 3 pallet, stack up to 4 high	38.5" W x 36" H x 36" D
3320D	Stack/store rack for sixteen 20 lb. cylinders, 3 x 3 pallet, with dividers, stack up to 4 high	38.5" W x 36" H x 36" D
3420	Stack/store rack for twenty 20 lb. cylinders, 3 x 4 pallet, stack up to 4 high	48" W x 36" H x 36" D
3420D	Stack/store rack for twenty 20 lb. cylinders, 3 x 4 pallet, with dividers, stack up to 4 high	48" W x 36" H x 36" D
DR220	Drain rack, 2 bay for 20 lb. cylinders, orange	
DR250	Drain rack, 2 bay for 50 lb. cylinders, orange	
DR420	Drain rack, 4 bay for 20 lb. cylinders, orange	
DR450	Drain rack, 4 bay for 50 lb. cylinders, orange	
DR520	Drain rack, 5 bay for 20 lb. cylinders, orange	
DR550	Drain rack, 5 bay for 50 lb. cylinders, orange	
FR2050	Fix-it rack for 20 or 50 lb. cylinders, orange	
C261	CO ₂ wrench	



CO₂ Detectors/Alarms

Carbon dioxide is a clear, tasteless and odorless toxic gas that in low concentrations can have negative effects in humans, and higher concentrations can be fatal. Protect yourself and your employees with a detector/alarm that warns when the CO₂ level becomes dangerous.

CO₂ hazards:

- 1% decreases your ability to work
- 2% causes headache and drowsiness
- 3% narcotic effect, blood pressure rises, hearing impairment
- 5% breathing difficulty and confusion
- 5-10% unconsciousness

If you store nitrogen and carbon dioxide mixtures where the nitrogen concentration is greater than 80%, you may also need to monitor the oxygen level.



Aspida



Analox 50

Analox 50

The Analox 50™ is fitted with audio visual alarms. When excess levels of carbon dioxide are detected an alarm is triggered. You should then ventilate the area and wait outside until the Analox 50 returns to safe mode (green light flashing only). At dangerous levels a second alarm warns of the need to immediately evacuate the area, until the monitor returns to safe mode.

The Analox 50 is also available with an oxygen sensor. 110 VAC or 9-24 VDC. CE and CSA-US approved. 15 year warranty.

Aspida Portable Detector/Alarm

The Analox Aspida is a personal alarm that protects workers from the dangers of elevated carbon dioxide and oxygen depletion. It also has a man down/panic alarm which will sound a loud (110db) audible alarm in the event of an employee collapsing. Alternatively, an employee can trigger the alarm manually in a panic situation.

Dual units monitor both CO₂ and O₂ levels. Single units monitor CO₂ or O₂ levels. Comes with two AA rechargeable batteries.

Part Number	Description
A50BC03X56EXXX16	Analox 50 CO ₂ wall mount detector/alarm
A50BC03X56EYXX16	Analox 50 CO ₂ and O ₂ wall mount detector/alarm
ASPBC0345601	Aspida personal CO ₂ and O ₂ detector/alarm
ASPBB0245601	Aspida personal CO ₂ detector/alarm
ASPBA0145601	Aspida personal O ₂ detector/alarm



McDantim Trumix™ Gas Blenders

The McDantim Trumix™ Blending Panel is a small wall-mounted unit that is easy to install, dependable, and requires no electricity, on-going maintenance or adjustment. It can be used with all sources of clean nitrogen and CO₂ including high pressure cylinders, bulk tanks or separators.

TM100 & TM100HF are for single blend (one beer) long draw beer systems. TM200 & TM200HF are for systems that dispense more than one type of beer requiring two separate blends of CO₂ and N₂.

Inlet Pressures: 55-150 psi, however, panel can be set to match any conditions. Outlet Pressures are adjustable from 0-60 psi. The maximum outlet pressure will always be 10 psi lower than the lowest inlet pressure. The panel can also be ordered with outlet pressure set to custom ranges.

MV013 (1/4") and MV042 (3/8") tee with check valve protects the blender from being filled with water when the blender is being using in conjunction with a carbonator. Trumix™ Blender warranty only covers water damage if a MV tee was installed.

MV035 - Inline Leak Indicator

The MV035 can easily determine if there is a leak and the size of the gas leak so you will know if the leak requires immediate attention or is hazardous to your employees.



MV013 1/4" tee with check valve
MV042 3/8" tee with check valve
Required for McDantim warranty



TM100 standard flow,
up to 15 kegs/hr.



TM100HF high flow,
up to 30 kegs/hr.



TM200 standard flow,
up to 30 kegs/hr.



TM200HF high flow,
up to 60 kegs/hr.
(30 kegs/hr. per blend)



Beer Regulators and Accessories

740 Series regulators have a polycarbonate bonnet that won't chip, break or fade. The non-adjustable "shut-down" safety can't be removed or easily circumvented. If the regulator seat fails the safety will respond instantly, isolating the product container from potentially dangerous high pressure. The product container pressure will not exceed the factory set blow-off of 55-65 PSI.

High pressure ports have left-hand female threads to prevent their use as a lo-pressure outlet... (If replacement parts are required, contact factory). The non-removable adjusting screw will never exceed 50 PSI. An internal relief valve opens whenever delivery pressure exceeds set pressure by 15 PSI. This feature serves as a warning that the seat or diaphragm may be worn or damaged and should be replaced. Seat assembly is easily replaceable in-field... no need to remove regulator from tank.

A sintered metal flow control filter in the inlet nipple prevents dirt and other particles from damaging internal parts. Permanent quad-ring seal on the inlet nipple eliminates a source of leaks, and there's no need to use a new fiber washer each time tank is changed.

The ball-type check valve helps prevent product back-up into the regulator. Hose barb end designed for use with 5/16" ID pressure tubing.



Part Number	Type of Regulator	PSI	Mount	Additional Info
T741	Primary	60	Tank	Single gauge with shut-off and relief valve
T742	Primary	2000 x 60	Tank	Dual gauge with shut-off and relief valve
T742HP	Primary		Tank	Dual gauge, high flow, with shut-off & relief valve
FC741H	Primary	30-45	Tank	Medium pressure for cold plate box dispensers, no gauge
FC741	Primary	12-18	Tank	Low pressure for underbar dispensing, no gauge
742N	Primary	3000 x 60	Tank	Nitrogen regulator, dual gauge with shut-off
T1661ST	Secondary, 1P x 1P	60	Wall	Single gauge with shut-off and relief valve
T1662ST	Secondary, 1P x 2P	60	Wall	Single gauge with shut-off and relief valve
T1672ST	Secondary, 2P x 2P	60	Wall	Two gauges with shut-off and relief valve
T1683ST	Secondary, 3P x 3P	60	Wall	Three gauges with shut-off and relief valve
T1694ST	Secondary, 4P x 4P	60	Wall	Four gauges with shut-off and relief valve
T1672STWMK	Secondary, 2P x 2P	60	Wall	Panel, 2 gauges with shut-off and relief valve
T1683STWMK	Secondary, 3P x 3P	60	Wall	Panel, 3 gauges with shut-off and relief valve
T1694STWMK	Secondary, 4P x 4P	60	Wall	Panel, 4 gauges with shut-off and relief valve

Regulator Accessories



Part Number	Size	Description
70003A	3'	High pressure hose assy.
70006A	6'	High pressure hose assy.
70009A	9'	High pressure hose assy.
7430		High pressure changeover valve
6600	1/4"	Shutoff outlet for BIB, no check, SAE male
6600C	1/4"	Shutoff outlet for BIB, with check, SAE male
5153B	1/4"x1/4"	Inlet fitting for secondary reg., MPT x SAE
5436	1/4"	Outlet fitting with check valve, SAE male
5436H	1/4"	Outlet fitting with check valve, hose barb
5232B	1/4"	Brass cap, SAE
5460	1/4"	Forged Y, (2) FPT x MPT
77006T		Replacement diaphragm assembly, new style
74019		Replacement CO ₂ nut and nipple assembly
77003C		Replacement seat assembly, new style
44017Q		Inlet nipple quad ring
C133		Regulator gauge cage
600GPS		Gauge boot protector
744GP		Gauge protector, all series
20W1005H02L30#		Gauge, 30 # PSIG RH thread
20W1005H02L60#		Gauge, 60 # PSIG RH thread
20W1005H02LXEPZ		Gauge, 100 # PSIG RH thread w/ marker
20W1005H02L100#		Gauge, 100 # PSIG RH thread
20W1005H02L160#		Gauge, 160 # PSIG RH thread
20W1005H02L300#		Gauge, 300 # PSIG RH thread
6603-2000		Gauge, 2000 # PSIG LH thread
5603		Gauge, 3000 # PSIG RH thread
6603		Gauge, 3000 # PSIG LH thread
PCO2NATURAL		Saturn washer, natural
63		Fiber CO ₂ washer
63NY		Nylon CO ₂ washer
44018		Wrench, CO ₂ regulator, Taprite
220016		Wrench, CO ₂ regulator, Lancer
4404PN		Guide nut tool
774015		Repair kit: 77003C, 77006T, 44017Q



Brass and Aluminum Air Distributors

Part #	Description
7016302	Brass air distributor, 2-way, safety
7016303	Brass air distributor, 3-way, safety
7016304	Brass air distributor, 4-way, safety
7016306	Brass air distributor, 6-way, safety
1741S	Aluminum air distributor, 1-way, safety
1742S	Aluminum air distributor, 2-way, safety
1743S	Aluminum air distributor, 3-way, safety
1744S	Aluminum air distributor, 4-way, safety
1741	Aluminum air distributor, 1-way
1742	Aluminum air distributor, 2-way
1743	Aluminum air distributor, 3-way
1744	Aluminum air distributor, 4-way

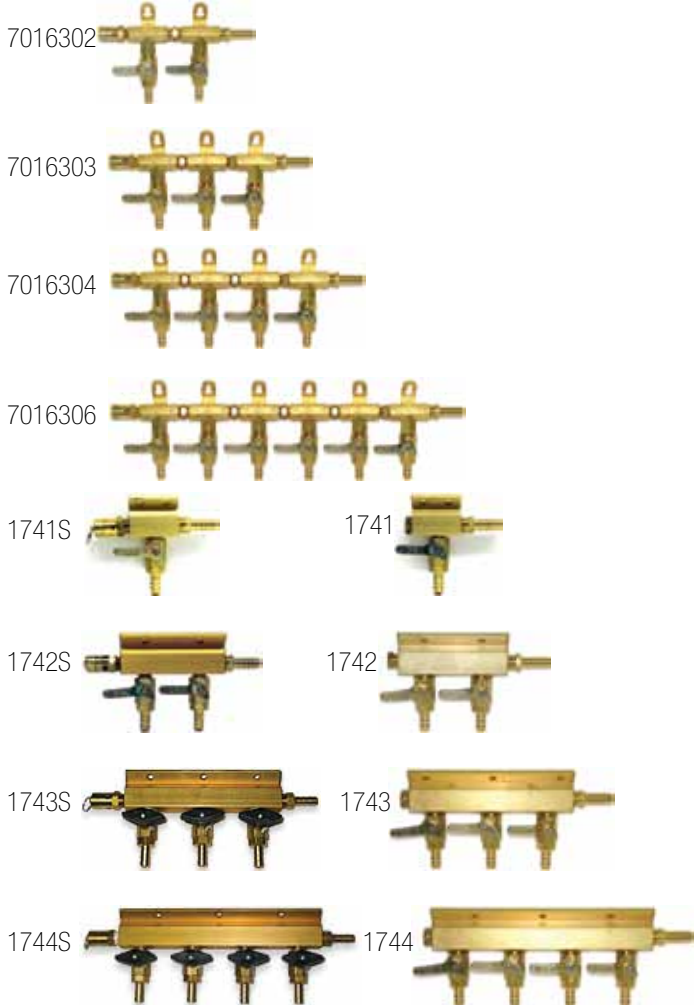

Thomas Air Compressor

T617HDN is a quiet, long-life 1/2 HP electric air compressor rated for continuous use. The compressor has a 2 gallon tank, internal thermal protection, inlet filter muffler, pressure gauge, drain valve, handle and 6' cord.

Running pressure: 100-125 psi
 Air displacement: 1.8 CFM.
 Air delivery: .9 CFM @ 100 psi.
 Low amp draw: 4.2
 Compressor dimensions: 16.5"L x 8"W x 16.8"H
 Carton dimensions: 19"L x 9.75"W x 17.25"H
 Shipping weight: 28 lbs.



T-617HDN

Part Number	Description
T617HDN	1/2 HP air compressor, NSF listed
13944	1/4" NPT x 1/4" barb fitting, brass
1904	Repair kit for T617HDN

T-617HDN repair kit includes:

- Piston cup
- Cup retainer screw
- Cylinder sleeve
- Head gasket O-ring
- Head screw
- Valve plate O-ring
- valve restraint
- Valve keeper strip
- Valve flapper
- Valve plate screw

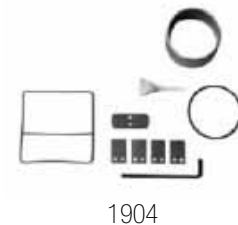

1904



BAR EQUIPMENT

ABS Air Compressor and Accessories



Oil-less air compressor with air line filter/regulator:

- Motor: 5/8 HP
- Voltage: 110V/60hz
- Output: 2.6 CFM
- Maximum pressure: 100 psi
- Operating pressure: 70-100 psi
- Noise level: 62 decibels
- Tank size: 2 gallons
- Includes filter/regulator with gauge
- Dimensions: 16.5"L x 13"W x 16"H, Weight: 37 lbs.
- Shipping dimensions: 15" x 17" x 18", Shipping weight: 45 lbs.



General Purpose Air Line Filter/Regulator

- 1/4 inch NPT female in/out ports 0-150 psi gauge
- 1/8 inch NPT female gauge port
- Maximum pressure 150 psi
- Adjustment range 0-120 psi
- Maximum flow 15 CFM
- 5 Micron filter



Automatic Condensate Drain Valve

- Timer specification: interval time 1-120 minutes, adjustable
- Supply voltage: 115V
- Valve specification: type 2/2 way direct acting
- In/out ports: 1/8 inch NPT female

Part Number	Description
CU012	Oil-less air compressor with filter/regulator
CU011	Oil-less air compressor with filter/regulator, auto drain valve and muffler
VAL039	General purpose air line filter/regulator
VAL038	Automatic condensate drain valve



Insulated Barrier Tubing Bundles with Coolant Lines

All bundles on this page have extruded jackets. Other jacket colors are available, some limitations may apply. Other bundle configurations are available, minimum order quantity may apply. Special lengths are available, additional cutting charges apply.



Part Number	# Lines	OD"	Line ID" x OD"	Brand	Std. Size	Clamp	Additional Info.
9710004002X250	6	3.0	(4) 3/8 x 1/2 (2) 3/8 x 1/2	Bev-Seal Ultra LLDPE (coolant)	250	14.0	
9710006002X250	8	3.4	(6) 3/8 x 1/2 (2) 3/8 x 1/2	Bev-Seal Ultra LLDPE (coolant)	250	14.0	
9730008002X250	10	3.5	(8) 3/8 x 1/2 (2) 3/8 x 1/2	Bev-Seal Ultra LLDPE (coolant)	250	14.0	
9730010004X250	14	3.8	(10) 3/8 x 1/2 (4) 3/8 x 1/2	Bev-Seal Ultra LLDPE (coolant)	250	14.0	
9730012004X250	16	4.0	(12) 3/8 x 1/2 (4) 3/8 x 1/2	Bev-Seal Ultra LLDPE (coolant)	250	14.0	
47470440C	4		(2) 3/8 x 1/2 (2) 3/8 x 1/2	Synflex Taste-Rite (coolant)	Custom cut	14.0	Extruded jacket
47470680C	6		(4) 3/8 x 1/2 (2) 3/8 x 1/2	Synflex Taste-Rite (coolant)	Custom cut	14.0	Extruded jacket
47470870C	8		(6) 3/8 x 1/2 (2) 3/8 x 1/2	Synflex Taste-Rite (coolant)	Custom cut	14.0	Extruded jacket
47471020C	10		(8) 3/8 x 1/2 (2) 3/8 x 1/2	Synflex Taste-Rite (coolant)	Custom cut	14.0	Extruded jacket
47471290C	12		(8) 3/8 x 1/2 (4) 3/8 x 1/2	Synflex Taste-Rite (coolant)	Custom cut	14.0	Extruded jacket
47471460C	14		(10) 3/8 x 1/2 (4) 3/8 x 1/2	Synflex Taste-Rite (coolant)	Custom cut	14.0	Extruded jacket
47471610C	16		(12) 3/8 x 1/2 (4) 3/8 x 1/2	Synflex Taste-Rite (coolant)	Custom cut	14.0	Extruded jacket
78B20295	4		(2) 3/8 x 1/2 (2) 3/8 x 1/2	Flo-Guard (coolant)	250	14.0	3/4" insulation, beer bundle
78B00694	6		(4) 3/8 x 1/2 (2) 3/8 x 1/2	Flo-Guard (coolant)	250	14.0	3/4" insulation, beer bundle
78B00893	8		(6) 3/8 x 1/2 (2) 3/8 x 1/2	Flo-Guard (coolant)	250	14.0	3/4" insulation, beer bundle
78B01090	10		(8) 3/8 x 1/2 (2) 3/8 x 1/2	Flo-Guard (coolant)	250	14.0	3/4" insulation, beer bundle
78B01492	14		(10) 3/8 x 1/2 (4) 3/8 x 1/2	Flo-Guard (coolant)	250	14.0	3/4" insulation, beer bundle
78B01691	16		(12) 3/8 x 1/2 (4) 3/8 x 1/2	Flo-Guard (coolant)	250	14.0	3/4" insulation, beer bundle



Insulated Barrier Tubing Bundles

All bundles on this page have taped jackets. Other jacket colors are available, some limitations may apply. Other bundle configurations are available, minimum order quantity may apply. Special lengths are available, additional cutting charges apply.



Part Number	# Lines	Line ID" x OD"	Brand	Std. Size	Clamp	Additional Info.
4747060TC	6	(4) 3/8 x 1/2 (2) 3/8 x 1/2	Synflex Taste-Rite (coolant)	Custom cut	14.0	Taped jacket
4747080TC	8	(6) 3/8 x 1/2 (2) 3/8 x 1/2	Synflex Taste-Rite (coolant)	Custom cut	14.0	Taped jacket
4747100TC	10	(8) 3/8 x 1/2 (2) 3/8 x 1/2	Synflex Taste-Rite (coolant)	Custom cut	14.0	Taped jacket
4747120TC	12	(8) 3/8 x 1/2 (4) 3/8 x 1/2	Synflex Taste-Rite (coolant)	Custom cut	14.0	Taped jacket
4747142TC	14	(10) 3/8 x 1/2 (4) 3/8 x 1/2	Synflex Taste-Rite (coolant)	Custom cut	14.0	Taped jacket
78001094	10	(10) 3/8 x 1/2	Flo-Guard	400'	14.0	1/2" insulation, soda bundle
78001294	12	(12) 3/8 x 1/2	Flo-Guard	400'	14.0	1/2" insulation, soda bundle
78060694	12	(6) 1/4 x 3/8 (6) 3/8 x 1/2	Flo-Guard	400'	10.5 14.0	1/2" insulation, soda bundle
78080340	11	(8) 1/4 x 3/8 (3) 3/8 x 1/2	Flo-Guard	400'	10.5 14.0	1/2" insulation, soda bundle

Beer Hose Assembly

Part #	Description
C110	Beer hose assembly, 3/16" ID, 7/16" OD, 5' long, hex nut on one end
C111	Beer hose assembly, 3/16" ID, 7/16" OD, 5' long, hex nut on both ends





Colored PVC Tubing

Clear, food grade liner materials free from colorants comply with FDA regulations.



Part Number	Line ID" x OD"	Brand	Std. Package	Clamp	Additional Info.
2030307x100	3/16 x 7/16	Bevlex	100' payout carton	12.3	Black, CO ₂ supply line
2030610x100	3/8 x 5/8	Bevlex	100' payout carton	17.0	Black, CO ₂ supply line
13081200	1/2 x 3/4	Arrow	100'	19.8	Black
13162000	1 x 1-1/4	Arrow	100'	31.6	Black
2040509x100	5/16 x 9/16	Bevlex	100' payout carton	15.7	Red, air supply line
2040610x100	3/8 x 5/8	Bevlex	100' payout carton	17.0	Red, air supply line
16050904	5/16 x 9/16	Arrow	100'	15.7	Red, air supply line
16050906	5/16 x 9/16	Arrow	100'	15.7	Blue, air supply line

Colored PVC Drain / General Purpose Tubing

General purpose, industrial grade PVC tube provides lightweight flexibility, kink resistance and economy.



Part Number	Line ID" x OD"	Brand	Std. Package	Clamp	Additional Info.
2150610000	3/8 x 5/8	Accuflex	100' payout carton	15.7	Gray
2150812000	1/2 x 3/4	Accuflex	100' payout carton	19.8	Gray
2151014000	5/8 x 7/8	Accuflex	100' boxed coil	22.6	Gray
2151216000	3/4 x 1	Accuflex	100' boxed coil	27.1	Gray
2151620000	1 x 1-1/4	Accuflex	100' wrapped coil	33.1	Gray
2131014	5/8 x 7/8	Accuflex	100' boxed coil	22.6	Black
213G1014	5/8 x 7/8	Accuflex	100' boxed coil	22.6	Green
213B1216	3/4 x 1	Accuflex	100' boxed coil	27.1	Blue
2131216000	3/4 x 1	Accuflex	100' boxed coil	27.1	Black
16050909	5/16 x 9/16	Arrow	100'		Black
16061009	3/8 x 5/8	Arrow	100'	15.7	Black
16081203	1/2 x 3/4	Arrow	100'	19.8	Gray
16081209	1/2 x 3/4	Arrow	100'	19.8	Black
16101403	5/8 x 7/8	Arrow	100'	22.6	Gray
16101405	5/8 x 7/8	Arrow	100'	22.6	Green
16121603	3/4 x 1	Arrow	100'	27.1	Gray
16162003	1 x 1-1/4	Arrow	100'	33.1	Gray
16121600	3/4 x 1	Arrow	100'	25.6	Blue
421612012	1/2 x 3/4	Eaton	100'	19.8	Gray
421614032	5/8 x 7/8	Eaton	100'	22.6	Gray
421616042	3/4 x 1	Eaton	100'	27.1	Gray
421620052	1 x 1-1/4	Eaton	100'	33.1	Gray



Sani-Clean AM™ Drain Tubing

Proprietary anti-microbial additive discourages fungal growth on the inner and outer surfaces. Translucent metallic gray color looks sanitary while allowing visual inspection while in service. Ideal for ice machines, dispensing equipment, condensate drains, and wherever protection from microorganisms is needed.



Part Number	Line ID" x OD"	Brand	Std. Package	Clamp
2180610x100	3/8 x 5/8	Sani-Clean	100' payout carton	17.0
2180812x100	1/2 x 5/8	Sani-Clean	100' payout carton	19.8
2181014x100	5/8 x 7/8	Sani-Clean	100' boxed carton	22.6
2181216x100	3/4 x 1	Sani-Clean	100' boxed carton	25.6
2181418x100	7/8 x 1-1/8	Sani-Clean	100' boxed carton	28.6
2181620x100	1 x 1-1/4	Sani-Clean	100' boxed carton	33.1

Corrugated PVC Drain Tubing

Manufactured with industrial grade materials, the drain tubing is light weight and non-marking. The rigid exoskeleton is virtually crush proof and offers a fantastic bend radius for tight turns.



Part Number	Line ID" x OD"	Brand	Std. Package	Clamp	Additional Info.
DHG20MMx100	3/4 x 1	Accuflex	100'	25.6	Gray
DHG27MMx100	1 x 1-5/16	Accuflex	100'	37.6	Gray
CD120003	3/4 x 1	Arrow	100'	25.6	Gray
CD160003	1 x 1-5/16	Arrow	100'	37.6	Gray

Thickened Water Mixing Assembly

Part Number	Description
ABSTHKMFLD	Mixing tube for thickened product

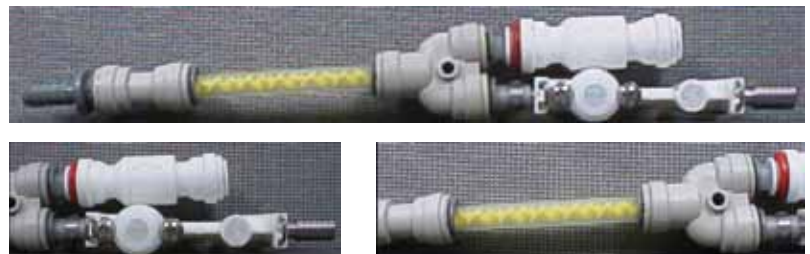



Tigerflex™ Drain Hose

Tigerflex has smooth bore flexible PVC to minimize internal flow restrictions, with rigid PVC helix reinforcement to provide exceptional kink resistance and a very tight bend radius for difficult installations. Tigerflex is generally used on ice maker and beverage dispenser drains.

Insulated Tigerflex is ideal for under-the-counter and fountain head areas because it keeps condensation from forming on the drain hose and then dripping on the floor. Antimicrobial insulation inhibits the growth of bacteria and other micro-organisms. Snug fitting insulation minimizes air entrapment beneath the insulation and condensation that might otherwise form. Insulated hoses are furnished in nominal 72" lengths.

Service Temperature: -4° to 150° F.

Tigerflex with antimicrobial insulation



Tigerflex without insulation



Part Number	Line ID" x OD"	Brand	Std. Package	Clamp	Additional Information
A15DHG050	1/2 x 11/16	Tigerflex	72"	19.8	Antimicrobial insulation
A15DHG20MM	3/4 x 1-1/16	Tigerflex	72"	27.1	Antimicrobial insulation
A15DHG27MM	1 x 1-3/8	Tigerflex	72"	34.6	Antimicrobial insulation
DHG050X100	1/2 x 11/16	Tigerflex	100'	19.8	Non-insulated
DHG20MMX100	3/4 x 1-1/16	Tigerflex	100'	27.1	Non-insulated
DHG27MMX100	1 x 1-3/8	Tigerflex	100'	34.6	Non-insulated



BAR EQUIPMENT

Metal Tubing

Part Number	Description	Std. Length
0312020304096	5/16" OD stainless steel	500'
0375020304096	3/8" OD stainless steel	300'
940004	5/16" stainless steel	10,000' coil
CPTUBE4	1/4" OD copper	50' coil
CPTUBE6	3/8" OD copper	50' coil



29



C200 tube sizing rod

Tubing Tools

Part Number	Description
29	Vice grip pinch-off tool
95101	Bundle tubing slicer
95401	Bundle tubing cutter
95603	Replacement blade for bundle cutter
95901	Accu-cutter
95903	Replacement blade for Accu-cutter
95801	Hose cutter
452304006	Hose cutter
C200	SS tube ID sizing rod: 3/16, 1/4, 5/16, 3/8"
953-01000-00	Jumbo bundle cutter, cuts 2.5" diameter bundles

Cable Ties



Standard

Part Number	Inches	Color	Qty.	Additional Info
084361	7.5	Natural	100	
084841	7.5	Natural	100	Screw mount
084271	15	Natural	100	
100350	14.5	Natural	100	Screw mount
100381	14.5	Natural	100	Heavy duty
SM0370N050NC	14.5	Natural	100	50 lb test w/ screw
SM038W120KC	14.5	Black	100	120 lb test w/ screw
084271	15	Natural	100	
CT0380W120KC	15	Black	100	120 lb test
084610	.75	Natural	N/A	Tie mount
083500	5	Natural		Secur-a-tie
083540	5	Red		Secur-a-tie

Lubricant



Part Number	Description
HLFT	4 oz food grade lubricant
FT101L	1 oz can lubricant



CPTUBE



953-01000-00



Metal Hose Clamps



Part Number	Description	Inch Range
62602	Adjustable hose clamp	1/4 - 5/8
435032E	Adjustable hose clamp	3/8 - 7/8
HC5212	Adjustable hose clamp	1/2 - 1-1/4
600024	Adjustable hose clamp	1-1/16 x 2
600040	Adjustable hose clamp	2-1/16 x 3
600056	Adjustable hose clamp	3-1/16 x 4
H2323	Snap clamp, nylon	

Plastic Hose Clamps



Part Number	Nominal OD"	Description
17007	7/16	Plastic hose clamp, white
17019	1/2	Plastic hose clamp, yellow
170211	9/16	Plastic hose clamp, red
170312	5/8	Plastic hose clamp, black
170415	3/4	Plastic hose clamp, blue



BAR EQUIPMENT

Armaflex® Insulation

Helps control temperature, condensation and mold and mildew growth. Sold in 6' sections.



Part Number	ID"	Thickness"	Std. Package'
1/2x3/8W	1/2	3/8	480
5/8x1/2W	5/8	1/2	300
7/8x1/2W	7/8	1/2	210
1-1/8x1/2W	1-1/8	1/2	150
1-5/8x1/2W	1-5/8	1/2	90
2-1/8x1/2W	2-1/8	1/2	60
2-1/2x1/2W	2-1/2	1/2	48
2-7/8x1/2W	2-7/8	1/2	36
4x1/2W	4	1/2	
1-5/8x3/4W	1-5/8	3/4	60
2-3/8x3/4W	2-3/8	3/4	48
R373	N/A	N/A	1 pint (adhesive)



Tapes

Part Number	Description
ME1795	Teflon tape
ME1985	Black electrical tape
ME7015200	Silver duct tape
NA398B	Black duct tape
421912	Foam insulation tape, 2" x 30'
P8612x2x30	Foam insulation tape, 2" x 30'

Stainless Steel Chase

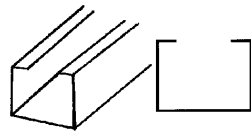

Part #	Size"	Description
26272	2.5 x 2.5 x 72	Chase, lid and hardware
25862	3 x 3 x 72	Chase, lid and hardware
608628	3 x 3 x 95	Chase with hardware
29915	4 x 4 x 48	Chase, lid and hardware, min. qty. 8
629919	4 x 4 x 72	Chase, lid and hardware
15629	6 x 6 x 72	Chase, lid and hardware
1070306	6 x 6 x 78	Chase, lid and hardware
629916	6 x 6 x 95	Chase, lid and hardware
600108	6 x 6 x 108	Chase, lid and hardware
608625	6 x 8 x 72	Chase
608625	6 x 8 x 72	Chase, lid and hardware
629917	6 x 10 x 95	Chase, lid and hardware

Line Labels



Part Number	Description
16N09126	Cherry
16N09143	Cherry Coke
16N09127	CO ₂ Gas
16N09142	Coca-Cola
16N09128	Cola
16N09129	Diet
16N09144	Diet Coke
16N09152	Diet Pepsi
16N09164	Diet Rite
16N09150	Dr. Pepper
16N09130	Ginger Ale
16N09132	Lemon Lime
16N09173	Lemonade
16N09145	Mello Yello
16N09154	Mountain Dew
16N09146	Mr. Pibb
16N09134	Orange
16N09155	Pepsi
16N09157	RC Cola
16N09135	Root Beer
16N09159	Seven Up
16N09179	Sierra Mist
16N09156	Slice
16N09136	Soda
16N09147	Sprite
16N09138	Sweet & Sour
16N09139	Tea
16N09140	Tonic
16N09141	Water
16N09163	Line Tape Dispenser
16N09188	Numbered Tape # 0
16N09189	Numbered Tape # 1
16N09190	Numbered Tape # 2
16N09191	Numbered Tape # 3
16N09192	Numbered Tape # 4
16N09193	Numbered Tape # 5
16N09194	Numbered Tape # 6
16N09195	Numbered Tape # 7
16N09196	Numbered Tape # 8
16N09197	Numbered Tape # 9



Oetiker Stepless Ear Clamps

Stepless ear clamps provide uniform compression and a 360° seal, ideal for securing beverage tubing to a fitting or outlet. -505R suffix means the band width is 5.0 mm and band thickness is .5 mm. -706R suffix means the band width is 7.0 mm and band thickness is .6 mm. Other sizes available, call customer service for more information.

When ordering always select the nominal size nearest to, but always larger than the outside diameter (OD) of the material to be clamped. Measurement should be determined with the connection fully assembled.



Part Number	Model	Nominal"	Closed-Open mm
16700983	7.0-505R	9/32	5.8 - 7
16700984	8.0-05R	5/16	6.8 - 8
16700985	8.7-505R	11/32	7 - 8.7
16700986	9.5-505R	3/8	7.8 - 9.5
16700987	10.0-505R	25/64	8.3 - 10
16700988	10.5-505R	13/32	8.8 - 10.5
16700989	11.3-505R	7/16	9.6 - 11.3
16700990	11.8-505R	15/32	10.1 - 11.8
16700992	12.3-706R	31/64	9.8 - 12.3
16700993	13.3-706R	1/2	10.8 - 13.3
16700997	14.0-706R	35/64	11.5 - 14
16700999	14.5-706R	9/16	12 - 14.5
16701005	15.7-706R	5/8	13.2 - 15.7
16701009	17.0-706R	21/32	14.5 - 17
16701015	18.5-706R	23/32	15.3 - 18.5
16701021	19.8-706R	3/4	16.6 - 19.8
16701029	21.0-706R	13/16	17.8 - 21
16701041	22.6-706R	7/8	19.4 - 22.6
16701072	25.6-706R	1	22.4 - 25.6
16701087	27.1-706R	1-1/16	23.9 - 27.1
16701103	28.6-706R	1-1/8	25.4 - 28.6
16701136	30.1-706R	1-11/64	26.9 - 30.1
16701203	33.1-706R	1-19/64	29.9 - 33.1
16701225	34.6-706R	1-23/64	31.4 - 34.6

Close clamp ear(s) fully.



opening permissible after crimping use of straight jaw pincer



use of side jaw pincer held parallel to hose



use of pneumatic power tool



Remove clamp by cutting through outer edge of ear with pincers.



To remove stepless or adjust

Crimpers/Pincers

Part Number	Description
C100	Economy pincers
14100082	Oetiker pincers
14100083	Oetiker side-jaw pincers



14100083



14100082



BAR EQUIPMENT

The following pictures are representations. Actual appearance may vary. Other fittings sizes and styles are available. Please call for details.

Stainless Steel Fittings



Part #	Size"	Description
1000222	1/4	Economy swivel nut, FFL, nickel plate brass
010222/01	1/4	Premium swivel nut, FFL, nickel plate brass
3196	1/4	Economy swivel nut, FFL, SS
1000227	5/16	Economy swivel nut, FFL, nickel plate brass
010227	5/16	Premium swivel nut, FFL, nickel plate brass
1000232	3/8	Economy swivel nut, FFL, nickel plate brass
010232/01	3/8	Premium swivel nut, FFL, nickel plate brass
3178	3/8	Premium swivel nut, FFL, SS
1002118	1/2	Economy swivel nut, FFL, nickel plate brass
012118	1/2	Premium swivel nut, FFL, nickel plate brass
1000215	1/8	Economy barb stem for 1/4" swivel nut
010215	1/8	Premium barb stem for 1/4" swivel nut
1000221	1/4	Economy barb stem for 1/4" swivel nut
010221/01	1/4	Premium barb stem for 1/4" swivel nut
1000229	1/8	Economy barb stem for 5/16" swivel nut
1000226	1/4	Economy barb stem for 5/16" swivel nut
010226	1/4	Premium barb stem for 5/16" swivel nut
1000231	1/4	Economy barb stem for 3/8" swivel nut
010231	1/4	Premium barb stem for 3/8" swivel nut
1000234	3/8	Economy barb stem for 3/8" swivel nut
010234	3/8	Premium barb stem for 3/8" swivel nut
1002121	1/2	Economy barb stem for 1/2" swivel nut
012121	1/2	Premium barb stem for 1/2" swivel nut
050011	1/4	Flare washer, plastic, white
050012	5/16	Flare washer, plastic, red
050017	3/8	Flare washer, plastic, black
050018	1/2	Flare washer, plastic, white



Part #	Size"	Description
7107	1/8	Plug, barb, SS
C194	3/16	Plug, barb, SS
1002119	1/4	Economy plug, barb, SS
TRC-8064PLUG	1/4 & 3/8	Economy plug, barb, plastic
052588	1/4, 3/8 & 1/2	Economy plug, barb, plastic
3220	5/16	Plug, barb, SS
1002120	3/8	Economy plug, barb
012120	3/8	Premium plug, barb
1002150	1/2	Economy plug, barb
012150	1/2	Premium plug, barb
1000017	1/4	Economy plug, MFL, SS
010017	1/4	Premium plug, MFL, SS
3032	5/16	Premium plug, MFL, SS
1000115	3/8	Economy plug, MFL, SS
010115	3/8	Premium plug, MFL, SS
7107	(2) 1/8	Premium splicer, barb, SS
526A2	(2) 3/16	Splicer, barb, nickel plate brass
1000590	(2) 1/4	Economy splicer, barb, SS
010590	(2) 1/4	Premium splicer, barb, SS
526B2	(2) 1/4	Splicer, barb, nickel plate brass
3220	(2) 5/16	Splicer, barb, nickel plate brass
526E2	(2) 5/16	Splicer, barb, nickel plate brass
10000592	(2) 3/8	Economy splicer, barb, SS
010592	(2) 3/8	Premium splicer, barb, SS
526C2	(2) 3/8	Splicer, barb, nickel plate brass
1000481	(2) 1/2	Economy splicer, barb, SS
010481	(2) 1/2	Premium splicer, barb, SS
526D2	(2) 1/2	Splicer, barb, nickel plate brass
7117	1/8 x 1/4	Premium splicer, reducing, SS
7118	1/8 x 3/8	Premium splicer, reducing, SS
526AB	3/16 x 1/4	Splicer, reducing, nickel plate brass
526AC	3/16 x 3/8	Splicer, reducing, nickel plate brass
526AE	3/16 x 5/16	Splicer, reducing, nickel plate brass
526AD	3/16 x 1/2	Splicer, reducing, nickel plate brass
1000594	1/4 x 3/8	Economy splicer, reducing, SS
010594	1/4 x 3/8	Premium splicer, reducing, SS
526BC	1/4 x 3/8	Splicer, reducing, nickel plate brass
3223	1/4 x 5/16	Premium splicer, reducing, SS











Advanced Beverage Solutions • Ph: 877-814-2271 • Fax: 847-524-1710 • E-mail: absco@absone.com • Visit us online at www.absone.com



BAR EQUIPMENT

The following pictures are representations. Actual appearance may vary. Other fittings sizes and styles are available. Please call for details.

Stainless Steel Fittings

	Part #	Size"	Description		Part #	Size"	Description
	526BE	1/4 x 5/16	Splicer, reducing, nickel plate brass		011280	(3) 1/4	Premium tee, barb, SS
	3137	1/4 x 1/2	Premium splicer, reducing, SS		1000526	(2) 1/4x3/8	Economy tee, barb, SS
	526BD	1/4 x 1/2	Splicer, reducing, nickel plate brass		010526	(2) 1/4x3/8	Premium tee, barb, SS
	3224	5/16 x 3/8	Premium splicer, reducing, SS		7065	(2) 1/4x1/2	Premium tee, barb, SS
	526CD	3/8 x 1/2	Splicer, reducing, nickel plate brass		1000525	(3) 3/8	Economy tee, barb, SS
	526CE	3/8 x 5/16	Splicer, reducing, nickel plate brass		010525	(3) 3/8	Premium tee, barb, SS
	3292	3/8 x 7/16	Premium splicer, reducing, SS		1000527	(2) 3/8x1/4	Economy tee, barb, SS
	1001723	3/8 x 1/2	Economy splicer, reducing, SS		010527	(2) 3/8x1/4	Premium tee, barb, SS
	011723	3/8 x 1/2	Premium splicer, reducing, SS		1001728	(2) 3/8x1/2	Economy tee, barb, SS
	526DE	1/2 x 5/16	Splicer, reducing, nickel plate brass		011728	(2) 3/8x1/2	Premium tee, barb, SS
	1000423	(2) 1/4	Economy elbow, barb, SS		1002122	(3) 1/2	Economy tee, barb, SS
	010423	(2) 1/4	Premium elbow, barb, SS		012122	(3) 1/2	Premium tee, barb, SS
	1000431	(2) 3/8	Economy elbow, barb, SS		7097	(2) 1/2x1/4	Premium tee, barb, SS
	010431	(2) 3/8	Premium elbow, barb, SS		1001724	(2) 1/2x3/8	Economy tee, barb, SS
	1002114	(2) 1/2	Economy elbow, barb, SS		011724	(2) 1/2x3/8	Premium tee, barb, SS
	012114	(2) 1/2	Premium elbow, barb, SS		7182	(3) 1/4	Premium tee, 2 barb x MPT, SS
	1000429	1/4 x 3/8	Economy elbow, barb, reducing, SS		C134	(3) 3/16	Premium tee, 2 barb x MPT, SS
	010429	1/4 x 3/8	Premium elbow, barb, reducing, SS		7185	(2) 3/8x1/4	Premium tee, 2 barb x MPT, SS
	7132	1/4 x 1/2	Premium elbow, barb, reducing, SS		7181	(2) 1/4x3/8	Premium tee, 2 barb x MPT, SS
	S2968	3/8 x 1/2	Economy elbow, barb, reducing, SS		7171	(3) 3/8	Premium tee, 2 barb x MPT, SS
	1000424	(2) 1/4	Economy elbow, swivel nut x barb, SS		7189	(2) 3/8x1/2	Premium tee, 2 barb x MPT, SS
	010424	(2) 1/4	Premium elbow, swivel nut x barb, SS		7168	(3) 1/2	Premium tee, 2 barb x MPT, SS
	1002113	1/4 x 3/8	Economy elbow, swivel nut x barb, SS		1007169	(2) 1/2x3/4	Economy tee, 2 barb x MPT, SS
	012113	1/4 x 3/8	Premium elbow, swivel nut x barb, SS		1002115	(3) 1/4	Premium Y tee, barb, 90° branch, SS
	1007059	3/8 x 1/4	Economy elbow, swivel nut x barb, SS		012115	(3) 1/4	Premium Y tee, barb, 90° branch, SS
	7153	5/16 x 1/4	Economy elbow, swivel nut x barb, SS		7075	(2) 1/4x3/8	Premium Y tee, barb, 90° branch, SS
	1000434	(2) 3/8	Economy elbow, swivel nut x barb, SS		1002117	(3) 3/8	Economy Y tee, barb, 90° branch, SS
	010434	(2) 3/8	Premium elbow, swivel nut x barb, SS		012117	(3) 3/8	Premium Y tee, barb, 90° branch, SS
	1003086	3/8 x 1/2	Economy elbow, swivel nut x barb, SS		1002129	(3) 1/2	Economy Y tee, barb, 90° branch, SS
	7191	(2) 1/2	Premium elbow, swivel nut x barb, SS		1000520	(3) 1/4	Economy flare tee, full MFL, SS
	7115	(3) 1/8	Premium tee, barb, SS		010520	(3) 1/4	Premium flare tee, full MFL, SS
	1001280	(3) 1/4	Economy tee, barb, SS		7021	(3) 5/16	Premium flare tee, full MFL, SS
					1000529	(3) 3/8	Economy flare tee, full MFL, SS
					010529	(3) 3/8	Premium flare tee, full MFL, SS
					1000522	(3) 1/4	Economy flare tee, 2 barb x MFL, SS
					010522	(3) 1/4	Premium flare tee, 2 barb x MFL, SS
					7025	(2) 1/4x3/8	Premium flare tee, 2 barb x MFL, SS



BAR EQUIPMENT

The following pictures are representations. Actual appearance may vary. Other fittings sizes and styles are available. Please call for details.

Stainless Steel Fittings

Part #	Size"	Description
	7024	(3) 3/8 Premium flare tee, 2 barb x MFL, SS
	7026	(2) 3/8x1/4 Premium flare tee, 2 barb x MFL, SS
	7045	(3) 3/8 Premium flare tee, 2 barb x MFL, SS
	1000518	(3) 1/4 Economy flare tee, 2 barb x swivel nut, SS
	010518	(3) 1/4 Premium flare tee, 2 barb x swivel nut, SS
	7082	(2) 3/8x1/4 Premium flare tee, 2 barb x swivel nut, SS
	7045	(3) 3/8 Premium flare tee, 2 barb x swivel nut, SS
	7055	(3) 1/4 Premium flare tee, 2 MFL x swivel nut, SS
	7102	(4) 1/8 Premium cross, barb, SS
	1000564	(4) 1/4 Economy cross, barb, SS
	010564	(4) 1/4 Premium cross, barb, SS
	1000565	(4) 3/8 Economy cross, barb, SS
	010565	(4) 3/8 Premium cross, barb, SS
	7081	(4) 1/2 Premium cross, barb, SS
	7019	(3) 1/4x3/8 Premium cross, barb, SS
	7180	(3) 1/4x1/2 Premium cross, barb, SS
	7111	(3) 3/8x1/4 Premium cross, barb, SS
	7106	(4) 1/4 Premium cross, barb, water fork, SS
	7137	(3) 1/4x3/8 Premium cross, barb, water fork, SS
	1007144	(4) 3/8 Economy cross, barb, water fork, SS
	7029	(4) 1/4 Premium cross, 3 barb x MFL, SS
	7031	(3) 1/4x3/8 Premium cross, 3 barb x MFL, SS
	7030	(3) 3/8x1/4 Premium cross, 3 barb x MFL, SS
	7032	(4) 3/8 Premium cross, 3 barb x MFL, SS
	7027	(4) 1/4 Premium cross, full MFL, SS
	7028	(4) 3/8 Premium cross, full MFL, SS
	1002123	(2) 1/4 Economy U-bend, barb, SS
	012123	(2) 1/4 Premium U-bend, barb, SS
	4047	(2) 5/16 Premium U-bend, barb, SS
	1002124	(2) 3/8 Economy U-bend, barb, SS
	012124	(2) 3/8 Premium U-bend, barb, SS
	1002125	(2) 1/2 Economy U-bend, barb, SS
	012125	(2) 1/2 Premium U-bend, barb, SS
	4050	(2) 3/4 Premium U-bend, barb, SS
	7015	1/4x1/4 Premium U-bend, 180°, swivel nut x barb, SS
	1002126	(3) 1/4 Economy U-bend, barb, SS
	012126	(3) 1/4 Premium U-bend, barb, SS
	1002128	(3) 3/8 Economy U-bend, barb, SS
	012128	(3) 3/8 Premium U-bend, barb, SS
	7066	(3) 1/2 Premium U-bend, barb, SS
	7157	(2) 1/4x1/8 Premium U-bend, barb manifold 1/8 port, SS
	1007126	(2) 1/4x3/8 Economy U-bend, barb manifold 3/8 port, SS
	7094	(2) 1/4x3/8 Premium U-bend, barb manifold 3/8 port small radius, SS
	1002127	(2) 3/8x1/4 Economy U-bend, barb manifold 1/4 barb port, SS
	012127	(2) 3/8x1/4 Premium U-bend, barb manifold 1/4 barb port, SS
	7143	(2) 3/8x1/2 U-bend, barb manifold 1/2 port, SS
	7159	(2) 1/2x1/4 Premium U-bend, barb manifold 1/4 barb port, SS
	7139	(2) 1/2x (2) 1/4 Premium U-bend, barb manifold 1/4 barb ports, SS
	7140	(2) 1/2x (3) 1/4 Premium U-bend, barb manifold 1/4 barb ports, SS
	7154	(2) 1/2x (5) 1/4 Premium U-bend, barb manifold 1/4 barb ports, SS
	7067	(2) 1/2x3/8 Premium U-bend, barb manifold 3/8 port, SS
	7155	(2) 1/4x1/4 Premium U-bend, barb manifold 1/4 MFL port, SS
	1000135	(2) 3/8x1/4 Economy U-bend, barb x 1/4 MFL port, SS
	010135	(2) 3/8x1/4 Premium U-bend, barb x 1/4 MFL port, SS
	7076	(2) 1/2x1/4 Premium U-bend, barb x 1/4 MFL port, SS
	7086	(2) 3/8x (3) 1/4 Premium U-bend, barb x 1/4 MFL port, SS
	7104	(2) 3/8x (4) 1/4 Premium U-bend, barb x 1/4 MFL port, SS
	7087	(2) 3/8x (5) 1/4 Premium U-bend, barb x 1/4 MFL port, SS
	7077	(2) 1/2x (3) 1/4 Premium U-bend, barb x 1/4 MFL port, SS
	7078	(2) 1/2x (5) 1/4 Premium U-bend, barb x 1/4 MFL port, SS
	7260	(2) 3/8x1/4 Premium U-bend, barb x 1/4 MPT port, SS



BAR EQUIPMENT

The following pictures are representations. Actual appearance may vary. Other fittings sizes and styles are available. Please call for details.

Stainless Steel Fittings



Part #	Size"	Description
1000244	(2) 1/4	Economy adapter, barb x 1/4 MFL, SS
010244	(2) 1/4	Premium adapter, barb x 1/4 MFL, SS
3016	1/4 x 5/16	Premium adapter, barb x 5/16 MFL, SS
1000251	1/4 x 3/8	Economy adapter, barb x 3/8 MFL, SS
010251	1/4 x 3/8	Premium adapter, barb x 3/8 MFL, SS
1000245	3/8 x 1/4	Economy adapter, barb x 1/4 MFL, SS
010245	3/8 x 1/4	Premium adapter, barb x 1/4 MFL, SS
3018	3/8 x 5/16	Premium adapter, barb x 5/16 MFL, SS
1000252	(2) 3/8	Economy adapter, barb x 3/8 MFL, SS
010252	(2) 3/8	Premium adapter, barb x 3/8 MFL, SS
7244	1/2 x 1/4	Premium adapter, barb x 1/4 MFL, SS
S2722	(2) 1/8	Economy adapter, barb x 1/8 MPT, SS
3273	1/4 x 1/8	Premium adapter, barb x 1/8 MPT, SS
S2744	(2) 1/4	Economy adapter, barb x 1/4 MPT, SS
S2746	1/4 x 3/8	Economy adapter, barb x 3/8 MPT, SS
3240	1/4 x 3/8	Premium adapter, barb x 3/8 MPT, SS
3278	3/8 x 1/8	Premium adapter, barb x 1/8 MPT, SS
3243	3/8 x 1/4	Premium adapter, barb x 1/4 MPT, SS
S2766	(2) 3/8	Economy adapter, barb x 3/8 MPT, SS
S2768	3/8 x 1/2	Economy adapter, barb x 1/2 MPT, SS
3239	3/8 x 1/2	Premium adapter, barb x 1/2 MPT, SS
7262	3/8 x 3/4	Premium adapter, barb x 3/4 MPT, SS
S2786	1/2 x 3/8	Economy adapter, barb x 1/2 MPT, SS
S2788	(2) 1/2	Economy adapter, barb x 1/2 MPT, SS



Part #	Size"	Description
7170	1/2 x 3/4	Premium adapter, barb x 3/4 MPT, SS
S271212	3/4 x 3/4	Economy adapter, barb x 3/4 MPT, SS
1007037	(2) 1/4	Economy adapter, compression x barb
1007038	1/4 x 3/8	Economy adapter, compression x barb
1007039	5/16 x 1/4	Economy adapter, compression x barb
1007040	5/16 x 3/8	Economy adapter, compression x barb
1007041	3/8 x 1/4	Economy adapter, compression x barb
1007042	(2) 3/8	Economy adapter, compression x barb
1001376	3/8 x 1/4	Economy adapter, barb x swivel nut
011376	3/8 x 1/4	Premium adapter, barb x swivel nut
1007114	1/2 x 3/8	Premium adapter, barb x swivel nut
1002112	3/8 x 1/4	Economy adapter, barb x FFL
012112	3/8 x 1/4	Premium adapter, barb x FFL
S8644	(2) 1/4	Economy adapter, MFL x FPT
010357	3/8 x 1/4	Premium adapter, MFL x FFL
S8842	1/4 x 1/8	Economy adapter, MFL x MPT
1000338	(2) 1/4	Economy adapter, MFL x MPT
1000335	1/4 x 3/8	Economy adapter, MFL x MPT
S8864	3/8 x 1/4	Economy adapter, MFL x MPT
1000334	(2) 3/8	Economy adapter, MFL x MPT
S8868	3/8 x 1/2	Economy adapter, MFL x MPT
1000347	(2) 1/4	Economy union, MFL x MFL
010347	(2) 1/4	Premium union, MFL x MFL
1000348	1/4 x 5/16	Economy union, MFL x MFL
010348	1/4 x 5/16	Premium union, MFL x MFL
3003	(2) 5/16	Premium union, MFL x MFL
3005	3/8 x 1/4	Premium union, MFL x MFL
1000356	(2) 3/8	Economy union, MFL x MFL
010356	(2) 3/8	Premium union, MFL x MFL
7219	1/4 x 1/8	Premium adapter, elbow, barb x MPT
7190	1/4 x 3/8	Premium adapter, elbow, barb x MPT
7184	(2) 1/4	Premium adapter, elbow, barb x MPT



BAR EQUIPMENT

The following pictures are representations. Actual appearance may vary. Other fittings sizes and styles are available. Please call for details.

Stainless Steel Fittings

Part #	Size"	Description	Part #	Size"	Description		
	7223	3/8 x 1/8	Premium adapter, elbow, barb x MPT		9417807	1/4	Outlet 90° elbow, Shurflo
	7162	3/8 x 1/4	Premium adapter, elbow, barb x MPT		9417818	3/8	Outlet 90° elbow, Shurflo
	7166	(2) 3/8	Premium adapter, elbow, barb x MPT		9417851	1/2	Outlet 90° elbow, Shurflo
	7175	3/8 x 1/2	Premium adapter, elbow, barb x MPT		PM109	1/4	Inlet, straight, Wunder-Bar
	7188	3/8 x 3/4	Premium adapter, elbow, barb x MPT		PM1010	5/16	Inlet, straight, Wunder-Bar
	S318P8	(2) 1/2	Economy adapter, elbow, barb x MPT		PM1011	3/8	Inlet, straight, Wunder-Bar
	7215	1/2 x 3/4	Premium adapter, elbow, barb x MPT		PM1047	1/4	Inlet, straight long, Wunder-Bar
	7098	(2) 1/4	Premium union, FFL x MFL		PM1012	3/8	Inlet, straight long, Wunder-Bar
	7056	(2) 1/4	Premium union, FFL x FFL		PM1057	1/2	Inlet, straight long, Wunder-Bar
	S8966	(2) 3/8	Economy union, FFL x FFL		PM1061	1/4	Inlet, 45°, Wunder-Bar
	7014	(2) 1/4	Premium elbow, forged, 2 barbs		PM1059	3/8	Inlet, 45°, Wunder-Bar
	7156	(2) 3/8	Premium elbow, forged, 2 barbs		PM1079	1/2	Inlet, 45°, Wunder-Bar
	7249	(2) 1/2	Premium elbow, forged, 2 barbs		PM1013	1/4	Inlet, 90°, Wunder-Bar
	1000204	1/4	Economy cap nut, flare		PM1053	3/8	Inlet, 90°, Wunder-Bar
	010204	1/4	Premium cap nut, flare		PM1078	3/8	Inlet, long 90° Wunder-Bar
	1000212	3/8	Economy cap nut, flare		PM1058	1/2	Inlet, 90°, Wunder-Bar
	010212	3/8	Premium cap nut, flare		010337SP	1/4	Adaptor assy, Dole/GB
	7088	5/16 x 1/4	Premium adapter, compression x MFL		7124	3/8	Outlet straight, GB
	3068	3/8	Premium compression spacer		010804SP	3/8	Inlet, MH x Dole/GB
	3048		Premium valve plug, General Beverage		7128	1/4	Outlet 90° elbow, double O-rings, Dole/GB
	3049		Premium valve plug, Dole		7072	3/8	Outlet 90° elbow, double O-rings, Dole/GB
	20324030	1/4	Outlet straight, Flojet		7064	1/2	Outlet 90° elbow, double O-rings, Dole/GB
	20325030	3/8	Outlet straight, Flojet		526A	3/16	Hose stem/nipple
	20606100	1/2	Outlet straight, Flojet		526B	1/4	Hose stem/nipple
	20607100	1/4	Outlet 90° elbow, Flojet		526C	3/8	Hose stem/nipple
	20608100	3/8	Outlet 90° elbow, Flojet		526D	1/2	Hose stem/nipple
	7120	1/2	Outlet 90° elbow, Flojet		526E	5/16	Hose stem/nipple
	7049	1/4	Outlet 90° double ring, Flojet		582CP11	3/16 & 1/4	Hose stem/nipple elbow with beer hex nut
	7048	3/8	Outlet 90° double ring, Flojet		7167	3/16	Hose stem/nipple elbow
	7064	1/2	Outlet 90° double ring, Flojet		7176	1/4	Hose stem/nipple elbow
	7245	1/4	Outlet straight, Shurflo		7250	3/8	Hose stem/nipple elbow
	9417819	3/8	Outlet straight, Shurflo		525	1/2	Beer wing nut
	9417827	1/2	Outlet straight, Shurflo		1020	7/8	Beer swivel nut, nickel
					8016		Beer washer
					9400		Beer lever
					4016		Knurled cap nut, 10/24 thread
					3160		Knurled shoulder screw

Advanced Beverage Solutions • Ph: 877-814-2271 • Fax: 847-524-1710 • E-mail: absocs@absone.com • Visit us online at www.absone.com



BAR EQUIPMENT

The following pictures are representations. Actual appearance may vary. Other fittings sizes and styles are available. Please call for details.

Stainless Steel Fittings

Part #	Size"	Description
543A	1/4	Wall bracket
BWB66	3/8	Wall bracket
9401	3/8	Wall bracket, plastic body
9402	7/8	Wall bracket MPT, plastic body
V13S	(2) 1/4	Needle valve, MFL x MFL
V6S66	(2) 3/8	Needle valve, MFL x MFL
V16S	(2) 3/8	Needle valve, FFL x FFL
V17S	(2) 1/4	Needle valve, MFL x swivel nut
7017	1/4	Manifold, 8.5" long, (9) 1/4 MFL
7016	1/4	Manifold, 8.5" long, (7) 1/4 MFL
7050	1/4 & 3/8	Manifold, 8.5" long, (7) 1/4 MFL and (2) 3/8 MFL ends
7151	1/4 & 3/16	Manifold, 8" long, (5) 3/16 MFL and (2) 1/4 MFL ends
7152	1/4 & 3/16	Manifold, 8" long, (4) 3/16 MFL and (2) 1/4 MFL ends
72181	3/8 & 5/32	Manifold, 3.5" long, (2) 5/32 barbs, (2) 3/8 barbs ends
72183	3/8 & 5/32	Manifold, 4.5" long, (3) 5/32 barbs, (2) 3/8 barbs ends
72185	3/8 & 5/32	Manifold, 5.5" long, (4) 5/32 barbs, (2) 3/8 barbs ends
2002891	3/8 x 3/8	Manifold, UNF w 2 port x UNF
2002892	3/8 x 5/8	Manifold, UNF w 2 port x UNF
2002893	3/8 x 7/16	Manifold, UNF w 2 port x UNF
2002894	3/8 x 3/8	Manifold, UNF w 3 port x UNF
2002895	3/8 x 5/8	Manifold, UNF w 3 port x UNF
2002896	3/8 x 7/16	Manifold, UNF w 3 port x UNF
2002897	3/8 x 3/8	Manifold, UNF w 6 port x UNF
2002898	3/8 x 5/8	Manifold, UNF w 6 port x UNF
2002899	3/8 x 7/16	Manifold, UNF w 6 port x UNF
2003125	3/8	Manifold, 3/8, 5 port w valve
2003126	3/8	Manifold, 3/8, 6 port w valve
2003127	1/2	Manifold, 1/2, 5 port w valve
2003128	1/2	Manifold, 1/2, 6 port w valve
C229	7 mm ID	Tailpiece for European faucet shank
C233	10 mm ID	Tailpiece for European faucet shank
C811	7 mm ID	Chrome elbow for European faucet shank
C812	10 mm ID	Chrome elbow for European faucet shank
C813	7 mm ID	SS elbow for European faucet shank
C814	10 mm ID	SS elbow for European faucet shank

Part #	Size"	Description
C240	3/16 ID	SS tail piece
C115	1/4	Tail piece with 1/4" MFL (easily change from commercial to homebrew keg)
C118	19/32 x 1/4 FFL	Corny plug adapter, male end 19/32"-18 threads, other end 1/4" FFL
C601		Chrome keg coupler elbow
C603	3/16 ID	Chrome elbow nipple, 90° tail piece
C172	1/4 ID	Chrome elbow nipple, 90° tail piece
C621	3/16 ID	SS elbow nipple, 90° tail piece
C310	3/16	Gooseneck elbow for shank
C308		Shank grommet, 100 pack
C137	3/8	Beer "Y" fitting, 3/8" ID bore, 5/8" BSP thread, 2.5" H
C153	3/16	Barbed swivel nut & stem set
C221	1/4	Barbed swivel nut & stem set
C222	5/16	Barbed swivel nut & stem set
C192	1/2 x 5/8	Hex beer adapter, chrome, converts 5/8" keg coupler to 1/2" BSP
C706		Swivel elbow, 90°, for K & S keg couplers, built-in O-ring
FT872		Elbow fitting for FT86 and FT86P taps, nickel

Fittings Kits











Part #	Description
8012	Fittings starter kit
8025	Fittings starter kit, economy



BAR EQUIPMENT

The following pictures are representations. Actual appearance may vary. Other fittings sizes and styles are available. Please call for details.

Miscellaneous Brass Beer Fittings

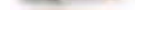
	Part #	Size"	Description
	70306	1/4	Tee, brass, 1/4 FPT
	1224	1/4	Hex nipple, MPT
	5460	1/4	Forged Y fitting
	70072	1/4	Plug, left hand MPT hex
	70081	1/4	Plug
	70203	1/4 x 2	Nipple, left hand MPT
	70248	1/4 x 2	Nipple, right hand MPT
	70167		Pressure relief valve for brass air distributors
	70168		Pressure relief valve for alum. air distributors
	C218		Basic kettle conversion kit, brass, converts any kettle without welding
	70030		Shut-off valve assembly
	70077	5/16	Nipple, MPT x barb



BAR EQUIPMENT

STOW 'N GO™ Tool Boxes

Durable Stow 'N Go™ Organizers are ideal for tools and small parts. Individual locking trays are partitioned for organization, and slide out for easy access.

135430 and 136430 Pro Racks

- Includes four ProLatch™ StowAway® organizers
- Bulk tool storage under the lid
- Graphite gray with sandstone accents



135430 Pro Rack

523201

- Removable dividers allow for 16-50 adjustable compartments
- 2-Sided convenience
- Bulk storage on both sides
- Lockjaw™ latches
- Porsche red w clear lids

523101

- Removable dividers allow for 15-52 adjustable compartments
- Double cover offers additional storage
- Large bulk storage area
- Lockjaw™ latches
- Porsche red w clear top



136430 Pro Rack

523002

- Removable dividers allow for 8-25 adjustable compartments
- Large bulk storage area
- Lockjaw™ latches
- Porsche red w clear lid

532430

- 24 Fixed Compartments
- Portable Organizer
- Clear



523201



523101



523002



532430

Part #	Description	Size"
135430	Stow 'N Go Pro Rack, graphite	11 x 7.25 x 10
136430	Stow 'N Go Pro Rack, graphite	13.375 x 10 x 14
523201	Stow 'N Go 2-Sided, red	14.5 x 4.63 x 11.75
523101	Stow 'N Go 1-Sided, red	14.5 x 3.38 x 11.75
523002	Stow 'N Go 1-Sided, red	14.5 x 2.38 x 11.75
523002	Stow 'N Go 1-Sided, clear	14.25 x 2.25 x 11.5



Conversion Stands and Leg Stands

Stainless steel conversion and leg stands convert drop-in ice chests to free-standing units. Conversion stands include a bottom shelf for a carbonator, removable access panels, and 6" adjustable legs.



Part Number	Description	Size W x D x H"
840006	Lancer conversion stand	17 x 25.25 x 36
840058	Lancer conversion stand	25 x 25 x 36
840059	Conversion stand, slide 32" for 30 x 23	31 x 25.5 x 36
CS1522	Conversion stand	17 x 25 x 36
CS2323	Conversion stand	25 x 25 x 36
CS2330	Conversion stand	30 x 23 x 35.25
161337	Conv. stand, knock down	17 x 25.25 x 36
161321	Conv. stand, knock down	25 x 25 x 36
LS1522KD	Leg stand, knock down	15 x 22 x 19.25
510389	Leg stand, Lancer	15 x 22 x 19.25
LS2123	Leg stand	21 x 23 x 19.25
LS2123KD	Leg stand, knock down, 80 lb	21 x 23 x 19.25
LS2123100	Leg stand, 100 lb	21 x 23 x 15.25
510652/01	Leg stand, Lancer, 100 lb	21 x 23 x 15.75
309999020602	False bottom CP shield	14W x 20D
309999020603	False bottom CP shield	15W x 23D
309999208003	False bottom CP shield	15.75W x 12D

False Bottom Cold Plate Shields

Stainless steel false bottoms fit over the cold plate and allow ice to surround the cold plate while separating consumable ice from the ice used to chill the cold plate. False bottoms are 12" wide.

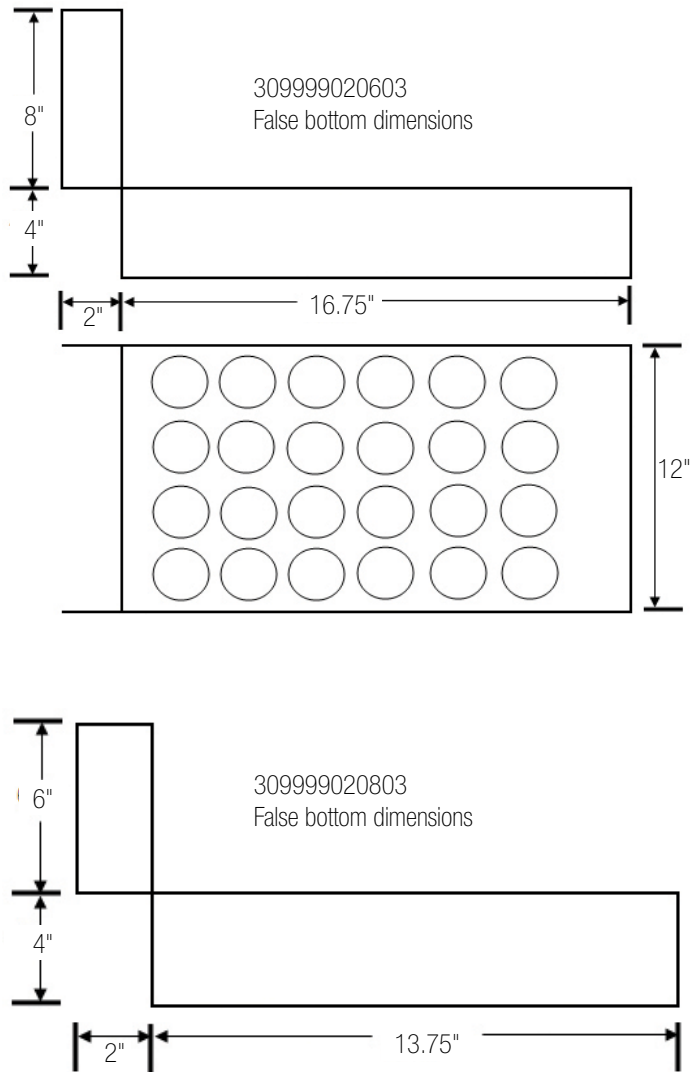



BAR EQUIPMENT

Images are representations.
Actual appearance may vary.



Ice Chests

Insulated drop-in and free-standing ice chests come in 3 sizes with up to 100 lb. ice capacity. All stainless steel construction. Ice chests come with a lid. Sealed-in cold plate is optional.

Stainless steel conversion and leg stands convert drop-in ice chests to free-standing units and are sold on the next page.

False bottoms separate consumable ice from the ice used to chill the cold plate and are sold on the next page.



Free-standing



Drop-in

Part Number	Type	Size W x D x H"	Rim"	Capacity Lbs.	Cold Plate
DI1522	Drop-in	15 x 22 x 14.25	16-7/8W x 23-7/8D	60	N/A
DI15227	Drop-in	15 x 22 x 14.25	16-7/8W x 23-7/8D	60	7 circuit premix
DI15228	Drop-in	15 x 22 x 14.25	16-7/8W x 23-7/8D	60	8 circuit postmix
850408	Drop-in, Lancer	22 x 15 x 14.25		60	8 circuit postmix
DI2123	Drop-in	21 x 23 x 14.25	22-3/4W x 24-3/4D	80	N/A
DI21237	Drop-in	21 x 23 x 14.25	22-3/4W x 24-3/4D	80	7 circuit premix
DI21239	Drop-in	21 x 23 x 14.25	22-3/4W x 24-3/4D	80	9 circuit postmix
DI2123100	Drop-in	21 x 23 x 18.25	22-3/4W x 24-3/4D	100	N/A
DI21239100	Drop-in	21 x 23 x 18.25	22-3/4W x 24-3/4D	100	9 circuit postmix
850402	Drop-in, Lancer	23 x 21 x 18		100	9 circuit postmix
20152203	Drop-in poly liner	15 x 22 x 14.25	N/A	60	N/A
20212303	Drop-in poly liner	21 x 23 x 14.25	N/A	80	N/A
FS1522	Free-standing	15 x 22 x 14.25 (+ 19.25H)	N/A	60	N/A
FS15227	Free-standing	15 x 22 x 14.25 (+ 19.25H)	N/A	60	7 circuit premix
FS15228	Free-standing	15 x 22 x 14.25 (+ 19.25H)	N/A	60	8 circuit postmix
850461	Free-standing, Lancer	22 x 15 x 14.25 (+ 19.5H)		60	8 circuit postmix
FS2123	Free-standing	21 x 23 x 14.25	N/A	80	N/A
FS21237	Free-standing	21 x 23 x 14.25	N/A	80	7 circuit premix
FS21239	Free-standing	21 x 23 x 14.25	N/A	80	9 circuit postmix
FS2123100	Free-standing	21 x 23 x 18.25	N/A	100	N/A
FS21239100	Free-standing	21 x 23 x 18.25	N/A	100	9 circuit postmix
850462	Free-standing, Lancer	23 x 21 x 18 (+ 19.5H)	N/A	100	9 circuit postmix
308260/02SP	Ice chest top lid	15W x 23D	N/A	N/A	N/A
308259/01SP	Ice chest bottom lid	15W x 23D	N/A	N/A	N/A
308269/02SP	Ice chest top lid	21W x 23D	N/A	N/A	N/A
308268/01SP	Ice chest bottom lid	21W x 23D	N/A	N/A	N/A



Ice Chests

Seamless top/backsplash has 2 tubing chase holes in the backsplash. Plastic breaker strip around the ice bin liner acts as a thermal barrier and makes the stainless steel covers slide easier. Fully insulated. Order with or without a 10 circuit cold plate. Models without cold plates have a 1.5" welded tailpiece so there's no drain fitting to break or come loose. All ice bins come with adjustable stainless steel bullet feet.

Prefixes: IBA = 19" deep, IBB = 24" deep, IB = pass-thru

Locking covers for speed rails are available: SSRC-X for single, DSRC-X for double speed rail. Replace X with the length needed.

More details available. Please visit www.glastender.com



Part Number	Length"	Depth"	Cold Plate	Lbs. Ice Capacity
IBA6	6	19	N/A	17
IBA12	12	19	N/A	33
IBA18	18	19	N/A	50
IBA24	24	19	N/A	67
IBA30	30	19	N/A	84
IBA36	36	19	N/A	100
IBA42	42	19	N/A	117
IBA48	48	19	N/A	134
IBA24CP10	24	19	10 circuit	67
IBA30CP10	30	19	10 circuit	84
IBA36CP10	36	19	10 circuit	100
IBA42CP10	42	19	10 circuit	117
IBA48CP10	48	19	10 circuit	134
IBB6	6	24	N/A	21
IBB12	12	24	N/A	42
IBB18	18	24	N/A	64
IBB24	24	24	N/A	85
IBB30	30	24	N/A	106
IBB36	36	24	N/A	127
IBB42	42	24	N/A	149
IBB48	48	24	N/A	170
IBB24CP10	24	24	10 circuit	85
IBB30CP10	30	24	10 circuit	106
IBB36CP10	36	24	10 circuit	127
IBB42CP10	42	24	10 circuit	149
IBB48CP10	48	24	10 circuit	170
IB38X24*	38	24	N/A	175
IB38X24CP10	38	24	10 circuit	175

*Made to order and not returnable.

Part Number	Description
SSR12	12" single speed rail
SSR18	18" single speed rail
SSR24	24" single speed rail
SSR30	30" single speed rail
SSR36	36" single speed rail
SSR42	42" single speed rail
SSR48	48" single speed rail
SSR54	54" single speed rail
SSR60	60" single speed rail
DSR12	12" double speed rail
DSR18	18" double speed rail
DSR24	24" double speed rail
DSR30	30" double speed rail
DSR36	36" double speed rail
DSR42	42" double speed rail
DSR48	48" double speed rail
DSR54	54" double speed rail
DSR60	60" double speed rail
SSRC-X	Single speed rail cover, replace X with length
DSRC-X	Double speed rail cover, replace X with length
IBDHA	Ice bin divider, half, for 19" deep ice bin
IBDHB	Ice bin divider, half, for 24" deep ice bin
IBDHAED	Ice bin divider, half, for 19" extra deep ice bin
IBDHBED	Ice bin divider, half, for 24" extra deep ice bin
IBDHP	Ice bin divider, half, for IB38X24
IBDHPCP	Ice bin divider, half, for IB38X24CP10
IBDHPLR	Ice bin divider, half, left to right for IB38X24
CCD	Condiment dispenser



Underbar Combo Ice Bin/Bottle Well

More details available. Please visit www.glastender.com

Separate draining ice bin and bottle well compartment are combined into one insulated stainless steel unit. Seamless top/backsplash has 2 tubing chase holes in the backsplash. Plastic breaker strip around the ice bin liner acts as a thermal barrier and makes the stainless steel covers slide easier. Order with or without a 10 circuit cold plate.

Fully insulated 12" bottle well has two wire racks for ice chilled storage of 6 or 8 bottles in 19" or 24" deep ice bins. The bottle well may be located on the left, right, or both sides of the ice bin.

Please specify right (R) or left (L) when ordering.



Combo ice bin with single speed rail



CCD condiment dispenser



BR3 bottle rack



BW3 bottle well

Part Number	Length"	Depth"	Cold Plate	Lbs. Ice Capacity	Bottle Capacity
CBA30	30	19	N/A	50	6
CBA36	36	19	N/A	67	6
CBA42	42	19	N/A	84	6
CBA48	48	19	N/A	100	6
CBA54	54	19	N/A	84	12
CBA60	60	19	N/A	100	12
CBA30CP10	30	19	10 circuit	67	6
CBA36CP10	36	19	10 circuit	84	6
CBA42CP10	42	19	10 circuit	67	12
CBA48CP10	48	19	10 circuit	100	6
CBA54CP10*	54	19	10 circuit	84	12
CBA60CP10*	60	19	10 circuit	100	12
CBB30	30	24	N/A	64	8
CBB36	36	24	N/A	85	8
CBB42	42	24	N/A	106	8
CBB48	48	24	N/A	127	8
CBB54	54	24	N/A	106	16
CBB60	60	24	N/A	127	16
CBB36CP10	36	24	10 circuit	85	8
CBB42CP10	42	24	10 circuit	106	8
CBB48CP10	48	24	10 circuit	127	8
CBB54CP10	54	24	10 circuit	106	16
CBB60CP10	60	24	10 circuit	127	16

*Made to order and not returnable.

Part Number	Description
BW3	Bottle well for 19" deep ice bin
BW4	Bottle well for 24" deep ice bin
BR3	Bottle rack for 19" deep ice bin
BR4	Bottle rack for 24" deep ice bin
SHA4	19"D soda gun holder, 4" long, 1-10 buttons
SHA414	19"D soda gun holder, 4" long, 12-14 buttons
SHA6	19"D soda gun holder, 6" long, 1-10 buttons
SHA614	19"D soda gun holder, 6" long, 12-14 buttons
SHB4	24"D soda gun holder, 4" long, 1-10 buttons
SHB414	24"D soda gun holder, 4" long, 12-14 buttons
SHB6	24"D soda gun holder, 6" long, 1-10 buttons
SHB614	24"D soda gun holder, 6" long, 12-14 buttons
TCA	Tubing chase, 6" long, 19" deep
TCB	Tubing chase, 6" long, 24" deep
CCD	Condiment dispenser



SHA4 Wunder-Bar soda gun holder



TCA tubing chase



Underbar Blender Stations

Blender stations come with a sink, faucet and wet waste strainer. Drainboard blender stations have a drainboard work surface consisting of a drain pan with separate removable perforated insert.

The integral blender shelf is 9" deep on the 24" deep models and 10" deep on the 29" models. The shelf stores the blender at the 19" high level. A grommeted cord access hole is provided in the front skirt.

Blender stations cannot have a speed rail mounted to them. Since speed rails are so common on the underbar, blender stations come in two depths to align with underbars with a speed rail: 24" (to align with 19" deep underbar) and 29" (to align with 24" deep underbar).

More details available. Please visit www.glastender.com



BSB18



DBSB18



IOS18



IBS12H



IBS12B



IBS12V

Part #	Length"	Depth"	Description
BSA12	12	24	Blender station with sink
BSA14	14	24	Blender station with sink
BSA18L	18	24	Blender station with sink, left faucet location
BSA18R	18	24	Blender station with sink, right faucet location
BSB12	12	29	Blender station with sink
BSB14	14	29	Blender station with sink
BSB18	18	29	Blender station with sink
DBSA12	12	24	Drainboard blender station
DBSA14	14	24	Drainboard blender station
DBSA18	18	24	Drainboard blender station
DBSA24*	24	24	Drainboard blender station
DBSB12*	12	29	Drainboard blender station
DBSB14*	14	29	Drainboard blender station
DBSB18*	18	29	Drainboard blender station
IBS12B	12	24	In-counter blender station for Blendtec™ Smoother, Titan or ABC
IBS12H	12	24	In-counter blender station for Hamilton Beach™ 91655 in-counter blender
IBS12V	12	24	In-counter blender station for Vita-Mix® Touch & Go Blending Station®
IOS18	18	29	Island Oasis® stand for Island Oasis® machine

Part Number	Description
LS15F	15" D left side splash, BSA models
RS15F	15" D right side splash, BSA models
LS15D	15" D left side splash, DBSA models
RS15D	15" D right side splash, DBSA models
LSAD	19" deep left end splash, BSB & DBSB models
RSAD	19" deep right end splash, BSB & DBSB models
TR	Towel ring



Towel ring

*Made to order and not returnable.



Underbar Drainboards

Glastender drainboards have an exclusive 1" deep sloped stainless steel drain pan with a separate removable perforated insert. The 1" high perforated insert allows air circulation beneath the glassware, and since the pan is sloped and not the insert, all glassware is stored on a level plane.

Drainboards are also available with a flat stainless steel fillerboard top in lieu of the drainboard top. Substitute an "F" for the "D" in the model number when ordering (same price). Fillerboards are manufactured to order and not returnable.

Recessed drainboards have the same drain pan with separate perforated insert, but the work surface has been lowered to allow glassware stacking. A perforated shelf is placed on top of the first level of glasses and a second layer is stacked on top (best if only one style of glassware is being stored).

More details available. Please visit www.glastender.com



DBA with single speed rail

DBA



RDBA

Part #	Length"	Depth"	Description
DBA12	12	19	Drainboard
DBA18	18	19	Drainboard
DBA24	24	19	Drainboard
DBA30	30	19	Drainboard
DBA36	36	19	Drainboard
DBA42	42	19	Drainboard
DBA48	48	19	Drainboard
DBB12	12	24	Drainboard
DBB18	18	24	Drainboard
DBB24	24	24	Drainboard
DBB30	30	24	Drainboard
DBB36	36	24	Drainboard
DBB42	42	24	Drainboard
DBB48	48	24	Drainboard
RDBA12S	12	24	Recessed DB, aligns w 19" UB, single speed rail
RDBA18S	18	24	Recessed DB, aligns w 19" UB, single speed rail
RDBA24S	24	24	Recessed DB, aligns w 19" UB, single speed rail
RDBA30S	30	24	Recessed DB, aligns w 19" UB, single speed rail
RDBB12	12	24	Recessed DB, aligns w 24" UB w/o speed rail
RDBB18	18	24	Recessed DB, aligns w 24" UB w/o speed rail
RDBB24	24	24	Recessed DB, aligns w 24" UB w/o speed rail
RDBB30	30	24	Recessed DB, aligns w 24" UB w/o speed rail
RDBA12D	12	29	Recessed DB, aligns w 19" UB, dbl speed rail
RDBA18D	18	29	Recessed DB, aligns w 19" UB, dbl speed rail
RDBA24D	24	29	Recessed DB, aligns w 19" UB, dbl speed rail
RDBA30D	30	29	Recessed DB, aligns w 19" UB, dbl speed rail
RDBB12S	12	29	Recessed DB, aligns w 24" UB, single speed rail
RDBB18S	18	29	Recessed DB, aligns w 24" UB, single speed rail
RDBB24S	24	29	Recessed DB, aligns w 24" UB, single speed rail
RDBB30S	30	29	Recessed DB, aligns w 24" UB, single speed rail

Part #	Description
SSR12	12" single speed rail
SSR18	18" single speed rail
SSR24	24" single speed rail
SSR30	30" single speed rail
SSR36	36" single speed rail
SSR42	42" single speed rail
SSR48	48" single speed rail
DSR12	12" double speed rail
DSR18	18" double speed rail
DSR24	24" double speed rail
DSR30	30" double speed rail
DSR36	36" double speed rail
DSR42	42" double speed rail
DSR48	48" double speed rail
TC*	4" x 4" x 6.5"H tubing chase

*Units with tubing chase (TC) added are made to order and not returnable.



Underbar Corner Drainboards

Corner drainboards are used when an underbar line-up turns 90° or less. The direction of the turn may be toward (inside corner) or away (outside corner) from the bartender. Corner drainboards have a removable perforated insert, align with 19" or 24" deep underbars, and come with a front rail to match adjacent equipment.

Dimensional full corner drainboards are for 90° inside turns only. If the dimensions of each side are not the same, the longest dimension is specified second along with its location.

Clip corner drainboards have a larger chamfer than full corner drainboards, and are designed for inside or outside turns 90° or less.

Corner drainboards are designed to mount between two pieces of underbar, however they can be mounted between any two stable vertical surfaces. If one side does not have a vertical surface on which to mount, then a side and leg set must be ordered.

More details available. Please visit www.glastender.com



Clip corner drainboard



Full corner drainboard with chase and perforated insert removed



Full corner drainboard without chase

Part #	Angle	Left"	Right"	Turn	Description
IFCA90	90°	19	19	Inside	90° full corner drainboard
OFCA90	90°	19	19	Outside	90° full corner drainboard
IFCB90	90°	24	24	Inside	90° full corner drainboard
OFCB90	90°	24	24	Outside	90° full corner drainboard
IFC19/19	90°	19	19	Inside	Dimensional full corner drainboard
IFC19/24L	90°	24	19	Inside	Dimensional full corner drainboard
IFC19/24R	90°	19	24	Inside	Dimensional full corner drainboard
IFC19/30L	90°	30	19	Inside	Dimensional full corner drainboard
IFC19/30R	90°	19	30	Inside	Dimensional full corner drainboard
IFC24/24	90°	24	24	Inside	Dimensional full corner drainboard
IFC24/30L	90°	30	24	Inside	Dimensional full corner drainboard
IFC24/30R	90°	24	30	Inside	Dimensional full corner drainboard
CALEG	N/A	N/A	N/A	N/A	Full side and leg set, 19" deep
CBLEG	N/A	N/A	N/A	N/A	Full side and leg set, 24" deep

Part #	Angle	Turn	Description
ICCA90	90°	Inside	19" deep clip corner
OCCA90	90°	Outside	19" deep clip corner
ICCA75	75°	Inside	19" deep clip corner
OCCA75	75°	Outside	19" deep clip corner
ICCA60	60°	Inside	19" deep clip corner
OCCA60	60°	Outside	19" deep clip corner
ICCA45	45°	Inside	19" deep clip corner
OCCA45	45°	Outside	19" deep clip corner
ICCA30	30°	Inside	19" deep clip corner
OCCA30	30°	Outside	19" deep clip corner
ICCA15	15°	Inside	19" deep clip corner
OCCA15	15°	Outside	19" deep clip corner
ICCB90	90°	Inside	24" deep clip corner
OCCB90	90°	Outside	24" deep clip corner
ICCB75	75°	Inside	24" deep clip corner
OCCB75	75°	Outside	24" deep clip corner
ICCB60	60°	Inside	24" deep clip corner
OCCB60	60°	Outside	24" deep clip corner
ICCB45	45°	Inside	24" deep clip corner
OCCB45	45°	Outside	24" deep clip corner
ICCB30	30°	Inside	24" deep clip corner
OCCB30	30°	Outside	24" deep clip corner
ICCB15	15°	Inside	24" deep clip corner
OCCB15	15°	Outside	24" deep clip corner



Underbar Drainboard Glassracks and Cabinets

More details available. Please visit www.glastender.com

Drainboard glassracks have a stationary or roll-out bottom shelf, adjustable or roll-out intermediate shelf, and drainboard work surface. All models are 24" deep. The 24" wide models hold 20" x 20" racks, and the 18" wide models hold the 16" round rack used with the Glastender GT18 glasswasher (racks not included). Since drainboard and glassrack shelves are solid, they can be used for non-glassrack storage. If a 19" deep drainboard glassrack is required, order a 19" deep drainboard glassrack less doors.

Drainboard cabinets are similar to glassracks, although the intermediate shelf is adjustable and available with or without doors. Models with doors come with a lock. The 12", 18" and 24" wide cabinets have one door, all others have two. Drainboard cabinets are also available with a flat stainless steel filler board in lieu of the drainboard top (substitute an "F" for the "D" in the model number), and made to order thus not returnable. Drainboard half cabinets are on 16" legs allowing cleaning underneath, and come with or without doors.



DBGR24RS



DBGR24



DBC18



DBHA18LD

Part #	Length"	Depth"	Description
DBGR18	18	24	Drainboard glassrack
DBGR24	24	24	Drainboard glassrack
DBGR24RS	24	24	Drainboard glassrack
DBCA12*	12	19	Drainboard cabinet, 1 door
DBCA18*	18	19	Drainboard cabinet, 1 door
DBCA24*	24	19	Drainboard cabinet, 1 door
DBCA30*	30	19	Drainboard cabinet, 2 doors
DBCA36*	36	19	Drainboard cabinet, 2 doors
DBCA42*	42	19	Drainboard cabinet, 2 doors
DBCA48*	48	19	Drainboard cabinet, 2 doors
DBC12	12	24	Drainboard cabinet, 1 door
DBC18	18	24	Drainboard cabinet, 1 door
DBC24	24	24	Drainboard cabinet, 1 door
DBC30	30	24	Drainboard cabinet, 2 doors
DBC36	36	24	Drainboard cabinet, 2 doors
DBC42	42	24	Drainboard cabinet, 2 doors
DBC48	48	24	Drainboard cabinet, 2 doors
DBCA12LD*	12	19	Drainboard cabinet
DBCA18LD*	18	19	Drainboard cabinet
DBCA24LD*	24	19	Drainboard cabinet
DBCA30LD*	30	19	Drainboard cabinet
DBCA36LD*	36	19	Drainboard cabinet
DBCA42LD*	42	19	Drainboard cabinet
DBCA48LD*	48	19	Drainboard cabinet
DBC12LD	12	24	Drainboard cabinet
DBC18LD	18	24	Drainboard cabinet
DBC24LD	24	24	Drainboard cabinet
DBC30LD	30	24	Drainboard cabinet
DBC36LD	36	24	Drainboard cabinet
DBC42LD	42	24	Drainboard cabinet
DBC48LD	48	24	Drainboard cabinet
DBHA12*	12	19	Drainboard 1/2 cabinet, 1 door
DBHA18*	18	19	Drainboard 1/2 cabinet, 1 door
DBHA24*	24	19	Drainboard 1/2 cabinet, 1 door
DBHA12LD*	12	19	Drainboard 1/2 cabinet
DBHA18LD*	18	19	Drainboard 1/2 cabinet
DBHA24LD*	24	19	Drainboard 1/2 cabinet
DBHB12*	12	24	Drainboard 1/2 cabinet, 1 door
DBHB18*	18	24	Drainboard 1/2 cabinet, 1 door
DBHB24*	24	24	Drainboard 1/2 cabinet, 1 door
DBHB12LD*	12	24	Drainboard 1/2 cabinet
DBHB18LD*	18	24	Drainboard 1/2 cabinet
DBHB24LD*	24	24	Drainboard 1/2 cabinet

*Made to order and not returnable.



Underbar Glassracks, Drainboard Drawer Units, POS Cabinets, Add-On Cabinet Bases

More details available. Please visit www.glastender.com

Glassracks are designed to hold three racks of glassware; one on the bottom shelf and one on each of the two adjustable glass rack slides. The 24" wide models hold 20" x 20" racks (not included), and the 18" wide models hold the 16" round racks (not included) with the Glastender GT18 glasswasher.

Drainboard drawer units have a removable locking drawer and drainboard surface. This allows for more storage space without sacrificing the ability to have a speed rail. Special speed rails (listed below) are required with drawer units. 19" drainboard drawer units are made to order and not returnable.

The add-on cabinet base is installed beneath standard underbar equipment to provide additional storage and enhance the look of the bar by eliminating storage of loose items under the bar and makes plumbing less visible. The back of the cabinet provides access to plumbing. The removable stainless steel floor has radius corners for easy cleaning, and interior walls are dual panel for a smooth interior and cleaning ease.

POS cabinets have a 26" high work surface to accommodate a cash drawer and POS monitor. Left and right side splashes are standard, as well as a louvered door to ventilate the storage cabinet. The work surface has a grommeted cord access hole.



GRA24



DBDA18



PCB24



DBDA-SSR-ACB



ACB

Part #	Length"	Depth"	Description
GRA18	18	19	Glassrack
GRA24	24	19	Glassrack
GRB18	18	24	Glassrack
GRB24	24	24	Glassrack
DBDA18*	18	19	Drainboard drawer unit
DBDA24*	24	19	Drainboard drawer unit
DBDA30*	30	19	Drainboard drawer unit
DBDB18*	18	24	Drainboard drawer unit
DBDB24*	24	24	Drainboard drawer unit
DBDB30*	30	24	Drainboard drawer unit
ACB12*	12	24	Add-on cabinet base, 1 door
ACB14*	14	24	Add-on cabinet base, 1 door
ACB18*	18	24	Add-on cabinet base, 1 door
ACB24*	24	24	Add-on cabinet base, 2 doors
ACB30*	30	24	Add-on cabinet base, 2 doors
ACB36*	36	24	Add-on cabinet base, 2 doors
ACB42*	42	24	Add-on cabinet base, 2 doors
ACB48*	48	24	Add-on cabinet base, 2 doors
PCB18	18	24	Point of sale (POS) cabinet
PCB24	24	24	Point of sale (POS) cabinet
SSR18D	N/A	18 long	Speed rail, drainboard drawer
SSR24D	N/A	24 long	Speed rail, drainboard drawer
SSR30D	N/A	30 long	Speed rail, drainboard drawer

*Made to order and not returnable.



Underbar Single Bowl Sinks

More details available. Please visit www.glastender.com

Single bowl sinks are available as hand sinks and wet waste sinks. Wet sinks include a lift-out perforated plastic wet waste strainer. All sinks come with a mounted hot and cold gooseneck faucet.

Hand sink models HSA12D, HSB12D and HSB12AD include a soap dispenser (refill from above) front-skirt-mounted and C-fold paper towel dispenser. Models DHSA18, DHSB12 and DHSB18 include a soap dispenser and hinged front-access door to conceal C-fold paper towel dispenser, which are easily accessed below the door. (The access door is only opened for re-loading the paper towel dispenser.)

Specialty Wet Waste Sinks:

Model SWB12C has a cabinet base with storage space for three 1-gallon chemical containers. Model SWB18DW has a cabinet base with work surface trash chute hole and front hinged access door (stainless steel trash container, model DWC, is available as an accessory). Model SWB18DB has a drainboard work surface with recessed wet waste sink below. Models SWB24LC and SWB24RC (L or R in the model number designates the sink location) include a 12" drain board section in the work surface and an open front cabinet base with center vertical divider.



SWB24LC



SWB12C



SWB18DW



DHSB12



SWB18DB



HSB12AD

Part #	Length"	Depth"	Description
HSA12	12	19	Hand sink
HSA18	18	19	Hand sink
HSA12D	12	19	Hand sink, soap & towel disp.
DHSA18	18	19	Hand sink
HSB12	12	24	Hand sink
HSB18	18	24	Hand sink
HSB12D	12	24	Hand sink, soap & towel disp.
HSB12AD	12	24	Hand sink, soap & towel disp.
DHSB12	12	24	Hand sink, soap & towel disp.
DHSB18	18	24	Hand sink, soap & towel disp.
SWA12	12	19	Wet waste sink
SWA18	18	19	Wet waste sink
SWB12	12	24	Wet waste sink
SWB18	18	24	Wet waste sink
SWB12C	12	24	Wet waste sink, cabinet base
SWB18DW	18	24	Wet waste sink, cabinet, chute
SWB18DB	18	24	Wet waste sink, cabinet w door, drainboard
SWB24LC	24	24	Wet waste sink, cabinet, drainboard, divider
SWB24RC	24	24	Wet waste sink, cabinet, drainboard, divider

Part #	Description
SSR12	12" single speed rail
SSR18	18" single speed rail
DSR12	12" double speed rail
SDR18	18" double speed rail
03000483	Wet waste sink strainer
TR	Towel ring
DWR12	Dry waste rail
DWC	Dry waste container
LSAD	19" deep left end splash
RSAD	19" deep right end splash
LSBD	24" deep left end splash
RSBD	24" deep right end splash
TDC	Paper towel dispenser, C-fold
03001873	Liquid soap dispenser, hand pump

Speed rails and dry waste rails cannot be mounted to models:
HSA12D, DHSA18, HSB12D, HSB12AD, DHSB12, DHSB18,
SWB12C, SWB18DW, SWB18DB, SWB24LC, SWB24RC

TDC paper towel dispenser cannot be mounted to models:
SWB12C, SWB18DW, SWB18DB, SWB24LC, SWB24RC



Underbar Multiple Bowl Sinks

Multiple sinks come in three different styles: two, three and four compartment. They feature an exclusive one-piece 18 gauge stainless steel top that is seamless from the front rail all the way through the backsplash.

Each style is available with or without built-in drainboards on one or both sides of the sink compartments. Drainboards, where included, are a seamless and integral part of the work surface and have a lift-out perforated insert. The seamless weld bowls are 16 gauge fabricated stainless steel. An "L" or "R" designates the location of the sink compartment as left or right when there is only one drainboard.

All sinks include one overflow tube per bowl. 19" deep models have a backsplash mounted faucet. Perforated stainless steel inserts are available to cover sinks when not in use.



Part #	Description
SSR24	24" single speed rail
SSR36	36" single speed rail
SSR48	48" single speed rail
SSR60	60" single speed rail
SSR66	66" single speed rail
SSR72	72" single speed rail
SSR84	84" single speed rail
DSR24	24" double speed rail
DSR36	36" double speed rail
DSR48	48" double speed rail
DSR60	60" double speed rail
DSR66	66" double speed rail
DSR72	72" double speed rail
DSR84	84" double speed rail
TR	Towel ring
LWS	Large wet waste strainer
DWR12	Dry waste rail
03002552	Sink cover, perforated, DSA or DSB
03002553	Sink cover, perforated, TSA or TSB
03002554	Sink cover, perforated, FSA or FSB

Part Number	Number Sinks	Overall Length"	Depth"	Sink Location	Drain-Board"
DSA24S*	2	24	19	Center	N/A
DSA36LS*	2	36	19	Left	12
DSA36RS*	2	36	19	Right	12
DSA48S*	2	48	19	Center	2@12
DSB24S*	2	24	24	Center	N/A
DSB36LS*	2	36	24	Left	12
DSB36RS*	2	36	24	Right	12
DSB48S*	2	48	24	Center	2@12
TSA36S	3	36	19	Center	N/A
TSA48LS*	3	48	19	Left	12
TSA48RS*	3	48	19	Right	12
TSA60S	3	60	19	Center	2@12
TSA60LS*	3	60	19	Left	24
TSA60RS*	3	60	19	Right	24
TSA66LS*	3	66	19	Left	30
TSA66RS*	3	66	19	Right	30
TSA72S	3	72	19	Center	2@18
TSA84S	3	84	19	Center	2@24
TSA96S*	3	96	19	Center	2@30
TSB36S	3	36	24	Center	N/A
TSB48LS*	3	48	24	Left	12
TSB48RS*	3	48	24	Right	12
TSB60S	3	60	24	Center	2@12
TSB60LS*	3	60	24	Left	24
TSB60RS*	3	60	24	Right	24
TSB66LS*	3	66	24	Left	30
TSB66RS*	3	66	24	Right	30
TSB72S	3	72	24	Center	2@18
TSB84S	3	84	24	Center	2@24
TSB96S*	3	96	24	Center	2@30
FSA48S	4	48	19	Center	N/A
FSA60LS*	4	60	19	Left	12
FSA60RS*	4	60	19	Right	12
FSA66LS*	4	66	19	Left	18
FSA66RS*	4	66	19	Right	18
FSA72S	4	72	19	Center	2@12
FSA72LS*	4	72	19	Left	24
FSA72RS*	4	72	19	Right	24
FSA84S	4	84	19	Center	2@18
FSA96S*	4	96	19	Center	2@24
FSB48S	4	48	19	Center	N/A
FSB60LS*	4	60	19	Left	12
FSB60RS*	4	60	19	Right	12
FSB66LS*	4	66	19	Left	18
FSB66RS*	4	66	19	Right	18
FSB72S	4	72	19	Center	2@12
FSB72LS*	4	72	19	Left	24
FSB72RS*	4	72	19	Right	24
FSB84S	4	84	19	Center	2@18
FSB96S*	4	96	19	Center	2@24

*Made to order and not returnable.



Underbar Beer Drainers and Liquor Displays

More details available. Please visit www.glastender.com

Beer drainers have a 26" high, lowered work surface designed for use with an undercounter beverage dispenser. The work surface includes a drain pan with perforated insert to serve as the drip pan for the dispenser with a tubing chase notched rear deck for beverage line installation and access.

Liquor displays provide tiered liquor bottle storage at a convenient height for bartenders. Each step and rail has sound deadening

covers, and each rail includes a clear lift-off liquor identification cover, and radius interior corners for easy cleaning. The 24" deep models provide four tiers, and 29" deep models provide five. Liquor displays cannot have a speed rail mounted to them but align with underbar with a speed rail, and appearance matches a speed rail for continuity. Locking speed rail covers can be used on each row.

Slanted liquor displays are used with 20" x 20" racks. Cabinet model has a locking door and 2" casters.



Beer drainer



LDA18S



SLD24



SLDC24

Part #	Length"	Depth"	Description
BDA18*	18	19	Beer drainer
BDA24*	24	19	Beer drainer
BDA30*	30	19	Beer drainer
BDA36*	36	19	Beer drainer
BDB18*	18	24	Beer drainer
BDB24*	24	24	Beer drainer
BDB30*	30	24	Beer drainer
BDB36*	36	24	Beer drainer
LDA12S	12	24	Liquor display, aligns w 19" UB w speed rail
LDA18S	18	24	Liquor display, aligns w 19" UB w speed rail
LDA24S	24	24	Liquor display, aligns w 19" UB w speed rail
LDA30S	30	24	Liquor display, aligns w 19" UB w speed rail
LDA36S	36	24	Liquor display, aligns w 19" UB w speed rail
LDA42S	42	24	Liquor display, aligns w 19" UB w speed rail
LDB12	12	24	Liquor display, aligns w 24" UB w/o speed rail
LDB18	18	24	Liquor display, aligns w 24" UB w/o speed rail
LDB24	24	24	Liquor display, aligns w 24" UB w/o speed rail
LDB30	30	24	Liquor display, aligns w 24" UB w/o speed rail
LDB36	36	24	Liquor display, aligns w 24" UB w/o speed rail
LDB42	42	24	Liquor display, aligns w 24" UB w/o speed rail
LDA12D	12	29	Liquor display, aligns w 19" UB w dbl speed rail
LDA18D	18	29	Liquor display, aligns w 19" UB w dbl speed rail
LDA24D	24	29	Liquor display, aligns w 19" UB w dbl speed rail
LDA30D	30	29	Liquor display, aligns w 19" UB w dbl speed rail
LDA36D	36	29	Liquor display, aligns w 19" UB w dbl speed rail
LDA42D	42	29	Liquor display, aligns w 19" UB w dbl speed rail
LDB12S	12	29	Liquor display, aligns w 24" UB w snl speed rail
LDB18S	18	29	Liquor display, aligns w 24" UB w snl speed rail
LDB24S	24	29	Liquor display, aligns w 24" UB w snl speed rail
LDB30S	30	29	Liquor display, aligns w 24" UB w snl speed rail
LDB36S	36	29	Liquor display, aligns w 24" UB w snl speed rail
LDB42S	42	29	Liquor display, aligns w 24" UB w snl speed rail
SLD24	24	24	Slanted liquor display
SLDC24	24	24	Slanted liquor display with cabinet

*Made to order and not returnable.



Underbar Dry Waste and Wait Stations

More details available. Please visit www.glastender.com

The top lifts up on all dry waste chutes to empty the trash receptacle, and lifts off for cleaning. DWB12 mounts between two adjacent pieces of underbar. DWB15L and DWB15R include a left or right side and leg set, and mount to one side of the underbar. DWB18 is freestanding. All models are designed to house a Rubbermaid® Slim Jim™ trash receptacle.

Dry waste rail looks like a speed rail but is a chute for a 16"H (or less) trash receptacle. Dry waste rails cannot be used on cabinets, glassracks or ice cream freezers.

Ice cream freezers are fully insulated, have dipper well and faucet, 6' grounded cord and plug, and 5 year compressor warranty. 24" unit holds one 3 gallon container of ice cream, 36" holds two.

Wait stations mount to the server side of the bar die for convenient storage of common server items. Cabinet includes menu holder, welded bowl with removable plastic wash basin, intermediate shelf, and special compartment for vertical 14" or 16" round server tray storage with a hole in the bottom to prevent trays from rolling out. No plumbing required. Includes wall mounting brackets.



Part #	Length"	Depth"	Description
DWB12	12	24	Dry waste chute
DWB15L	15	24	Dry waste chute, L side & legs
DWB15R	15	24	Dry waste chute, R side & legs
DWB18*	18	24	Dry waste chute, freestanding
DWR12	12	5	Dry waste rail
WS24	24	15	Wait station
WS36	36	15	Wait station
WS36S	36	15	Wait station, SS bowl, removable plastic washrag basin

Part #	Description
DWC	SS dry waste container
03000497	Slim Jim plastic trash receptacle
SSR24	Single speed rail for ice cream freezer
SSR36	Single speed rail for ice cream freezer
DSR24	Double speed rail for ice cream freezer
DSR36	Double speed rail for ice cream freezer
CE220/50S	Converts ice cream freezer to 220V/50Hz
WPH	Wall-mounted pan holder
WPHLP	Wall-mounted pan holder, less pan
MHL	Menu holder, mounts left
MHR	Menu holder, mounts right
03003317	1/4th pan, SS, 6" deep
03003318	1/4th pan, plastic, 6" deep
03003294	Plastic washrag basin

*Made to order and not returnable.



Underbar All-In-One Stations

More details available. Please visit www.glastender.com

All-in-one stations combine different underbar components into one pre-assembled unit, and can be ordered with or without a cold plate. Stations are 29" deep. Sinks include goose neck faucet. All-in-one stations are made to order and are not returnable.



Part Number w/o Cold Plate	Part Number with 10 Circuit Cold Plate	Width"	36" Combo Ice Bin	42" Combo Ice Bin	12" Single Wet Waste Sink	12" Single Wet Waste Sink, L Splash	12" Blender Shelf with Towel Ring	12" Liquor Display	18" Liquor Display	36" Double Speed Rail	42" Double Speed Rail	12" Dry Waste Rail	12" Recessed Drainboard	18" Recessed Drainboard	Condiment Dispenser
ALL60A	ALL60ACP10	60	X			X	X	X		X		X			X
ALL60B	ALL60BCP10	60	X			X	X			X		X	X		X
ALL66A	ALL66ACP10	66		X		X	X	X			X	X			X
ALL66B	ALL66BCP10	66		X		X	X				X	X	X		X
ALL66C	ALL66CCP10	66	X			X	X			X		X		X	X
ALL66D	ALL66DCP10	66	X		X	X			X	X		X			X
ALL72	ALL72CP10	72	X			X	X	X		X		X	X		X
ALL72A	ALL72ACP10	72		X		X	X		X		X	X			X
ALL72B	ALL72BCP10	72		X		X	X				X	X		X	X



Underbar Drink Rails, Drain Pans and Speed Rails

More details available. Please visit www.glastender.com

Drink rails mount to the underside of the bar top and have a removable perforated insert. 30" and 36" models have one gusset, 42" and 48" rails have two gussets for added strength. 1/2" welded tailpiece drain exits from the back. Installation kit includes: 10' of clear vinyl drain tube, one 4" Ty-wrap, three #10 SS wood screws, three cable clamps and one 1/2" x 1/2" x 1/2" plastic tee.

Drop-in drain pans fit into the countertop and self rimming edges fit tightly to the work surface. Comes with the same installation kit as drink rail except there are two 1/2" elbows rather than one tee. Standard lengths are from 24" to 48". Custom sizes also available.

Drink rails and drop-in drain pans are made to order and not returnable.

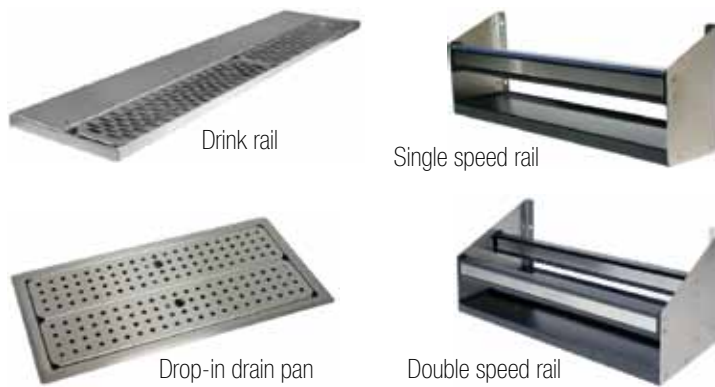

Part #	Size"	Description
DR12R	12	Drink rail, right side drain
DR18R	18	Drink rail, right side drain
DR24R	24	Drink rail, right side drain
DR30R	30	Drink rail, right side drain
DR36R	36	Drink rail, right side drain
DR42R	42	Drink rail, right side drain
DR48R	48	Drink rail, right side drain
DR12L	12	Drink rail, left side drain
DR18L	18	Drink rail, left side drain
DR24L	24	Drink rail, left side drain
DR30L	30	Drink rail, left side drain
DR36L	36	Drink rail, left side drain
DR42L	42	Drink rail, left side drain
DR48L	48	Drink rail, left side drain
DRIC45	N/A	45° inside corner filler
DRIC90	N/A	90° inside corner filler
DROC45	N/A	45° outside corner filler
DROC90	N/A	90° outside corner filler
DIDP12X24	12 x 24	Drop-in drain pan
DIDP12X30	12 x 30	Drop-in drain pan
DIDP12X36	12 x 36	Drop-in drain pan
DIDP12X42	12 x 42	Drop-in drain pan
DIDP12X48	12 x 48	Drop-in drain pan



Speed rails are stainless steel with radius corners, easy to clean and view bottles. Each rail has sound deadening covers and a clear lift-off liquor ID cover. Locking covers for single speed rails include built-in storage hangers when ordered with original equipment.

Part #	Size"	Description
SSR12TO17	12 - 17	Single speed rail
SSR18TO23	18 - 23	Single speed rail
SSR24TO29	24 - 29	Single speed rail
SSR30TO35	30 - 35	Single speed rail
SSR36TO41	36 - 41	Single speed rail
SSR42TO47	42 - 47	Single speed rail
SSR48TO53	48 - 53	Single speed rail
SSR54TO59	54 - 59	Single speed rail
SSR60TO65	60 - 65	Single speed rail
SSR66TO71	66 - 71	Single speed rail
SSR72TO77	72 - 77	Single speed rail
SSR78TO83	78 - 83	Single speed rail
SSR84	84	Single speed rail
DSR12TO17	12 - 17	Double speed rail
DSR18TO23	18 - 23	Double speed rail
DSR24TO29	24 - 29	Double speed rail
DSR30TO35	30 - 35	Double speed rail
DSR36TO41	36 - 41	Double speed rail
DSR42TO47	42 - 47	Double speed rail
DSR48TO53	48 - 53	Double speed rail
DSR54TO59	54 - 59	Double speed rail
DSR60TO65	60 - 65	Double speed rail
DSR66TO71	66 - 71	Double speed rail
DSR72TO77	72 - 77	Double speed rail
DSR78TO83	78 - 83	Double speed rail
DSR84	84	Double speed rail
SSRC12TO17	12 - 17	Single speed rail locking cover
SSRC18TO23	18 - 23	Single speed rail locking cover
SSRC24TO29	24 - 29	Single speed rail locking cover
SSRC30TO35	30 - 35	Single speed rail locking cover
SSRC36TO41	36 - 41	Single speed rail locking cover
SSRC42	42	Single speed rail locking cover
DSRC12TO17	12 - 17	Double speed rail locking cover
DSRC18TO23	18 - 23	Double speed rail locking cover
DSRC24TO29	24 - 29	Double speed rail locking cover
DSRC30TO35	30 - 35	Double speed rail locking cover
DSRC36TO41	36 - 41	Double speed rail locking cover
DSRC42	42	Double speed rail locking cover
CSR12SR	12	Clip-on single speed rail to existing single
CSR18SR	18	Clip-on single speed rail to existing single
CSR24SR	24	Clip-on single speed rail to existing single
CSR30SR	30	Clip-on single speed rail to existing single
CSR36SR	36	Clip-on single speed rail to existing single
CSR42SR	42	Clip-on single speed rail to existing single



Underbar Modular Bar Die

More details available. Please visit www.glastender.com

Underbar equipment is mounted to and supported on the bar die. All underbar equipment is pre-assembled and mounted to the bar die at the factory, then broken down into shippable sections. Installation of the bar die is simpler than a conventional millwork bar die and has many advantages...

The total number of feet required is calculated by determining the overall outside dimension of the bar die wall. Please round to the nearest whole foot.

Benefits:

- Stainless steel from floor to the bar top on bartender side
- Floor can be sealed to the bar die to prevent moisture from seeping from the bartender side to the customer side
- Galvanized steel will not rot
- Eliminates all underbar legs for easy cleaning
- Built-in chaseways for beer, soda, plumbing and electrical lines provide a cleaner, more attractive bar
- Can be used in conjunction with removable front millwork finishing panels to provide easy access to beer, soda, plumbing and electrical lines for future modification, maintenance or repair
- Pre-engineered to exact dimensions to ensure a precise fit
- Pre-assembly from the factory lowers installation costs
- Millwork bar top and front panels can be pre-fabricated and easily attached



Underbar with modular bar die

Part #	Description
MD	Modular bar die, priced per foot



Underbar without modular bar die



Underbar Parts and Accessories

Part #	Description
BO	Bottle opener
CLEG	6" leg for underbar cabinet
ULEG	16" leg for standard underbar
03000495	12" leg for extra-deep ice bin
03005473	Light, plug-in fluorescent for bar die
03001871	Cup, condiment dispenser replacement
03000484	Flanged foot, fits all equipment
06001549	Bullet foot, fits all equipment
06001557	Pilaster for GRA and GRB
06001565	Clip for pilaster, SS, for GRA and GRB
06001574	Thumbscrew, SS, for pilaster or shelf angle
03001093	Shelf angle, for DBCA or DBCB
03001915	Lock and cam, drainboard cabinet, 2 keys
03000474	Lock w 2 keys, speed rail or MBR cover
03000475	J-hook, locking speed rail cover
03000476	J-hook, for MBR24LC
03000477	J-hook, for MBR24CTL
03001923	10/32 x 3/4" black hand screw for bargun drip cup
03000457	Repl deck faucet, 7-3/8" gooseneck, UB unit 1 bowl
03000458	Repl deck faucet, 9" gooseneck, CS models
03000460	Repl deck faucet, 10" swing, DSB models
03000463	Repl backsplash faucet, 6" swing, for BSA12, HSA12, HSA12D, SWA12, DSA & WH models
03005754	Repl backsplash faucet, 10" swing, for TSA and 2-faucet FSA models
03000465	Repl backsplash faucet, 18" dbl joint, FSA models
03000466	Repl faucet, 7-3/8" gooseneck, spout only
03000467	Repl faucet, 9" gooseneck, spout only
03000468	Repl faucet, 6" swing, spout only
03002009	Repl faucet, 10" swing, spout only
03000469	Repl faucet, 12" swing, spout only
03000470	Repl faucet, 18" dbl joint, spout only
03000471	Repl faucet, deck mt, body only
03000472	Repl faucet, backsplash mt, body only
03000473	Repl faucet, glass filler, short
03001872	Repl faucet, glass filler, 9-3/8"H for DI-IW24
04000104	Repl faucet, dipper well
03000511	Wrist handles, set of two
03000441	Overflow tube for multiple sink
03001873	Liquid soap dispenser, hand-pump
01000766	1.5" IPS drain fitting kit
02000614	Drain screen, IDU, GDU, MIB, IBM, ice bins prior 8/03
02000616	Drain screen, stamped, ice bins post 8/03
03000443	18" open glass rack shelf
03000444	24" open glass rack shelf
BSS8	Bolt-on blender shelf, 8"
BSS12	Bolt-on blender shelf, 12"
BSS14	Bolt-on blender shelf, 14"
BSS16	Bolt-on blender shelf, 16"
BSS18	Bolt-on blender shelf, 18"
BSS24	Bolt-on blender shelf, 24"
BSS30	Bolt-on blender shelf, 30"

Part #	Description
LS15F	Side splash, 15" D left side, BSA models
RS15F	Side splash, 15" D right side, BSA models
LS15D	Side splash, 15" D left side, DBSA models
RS15D	Side splash, 15" D right side, DBSA models
LSAF	Side splash, 19" D left side for flat work surface
RSAF	Side splash, 19" D right side for flat work surface
LSBF	Side splash, 24" D left side for flat work surface
RSBF	Side splash, 24" D right side for flat work surface
03000422	12" W drainboard insert for 19" D unit
03000424	18" W drainboard insert for 19" D unit
03000426	24" W drainboard insert for 19" D unit
03000428	30" W drainboard insert for 19" D unit
03000430	36" W drainboard insert for 19" D unit
03000432	42" W drainboard insert for 19" D unit
03000434	48" W drainboard insert for 19" D unit
03000423	12" W drainboard insert for 24" D unit
03000425	18" W drainboard insert for 24" D unit
03000427	24" W drainboard insert for 24" D unit
03000429	30" W drainboard insert for 24" D unit
03000431	36" W drainboard insert for 24" D unit
03000433	42" W drainboard insert for 24" D unit
03000435	48" W drainboard insert for 24" D unit
IBCA12	Repl ice bin cover, 12" W for 19" D ice bin
IBCA18	Repl ice bin cover, 18" W for 19" D ice bin
IBCA24	Repl ice bin cover, 24" W for 19" D ice bin
IBCA30	Repl ice bin cover, 30" W for 19" D ice bin
IBCA36	Repl ice bin cover, 36" W for 19" D ice bin
IBCA42	Repl ice bin cover, 42" W for 19" D ice bin
IBCA48	Repl ice bin cover, 48" W for 19" D ice bin
IBCB12	Repl ice bin cover, 12" W for 24" D ice bin
IBCB18	Repl ice bin cover, 18" W for 24" D ice bin
IBCB24	Repl ice bin cover, 24" W for 24" D ice bin
IBCB30	Repl ice bin cover, 30" W for 24" D ice bin
IBCB36	Repl ice bin cover, 36" W for 24" D ice bin
IBCB42	Repl ice bin cover, 42" W for 24" D ice bin
IBCB48	Repl ice bin cover, 48" W for 24" D ice bin
03000163	Shelf, 12" W for 19" D cabinet
03000165	Shelf, 18" W for 19" D cabinet
03000167	Shelf, 24" W for 19" D cabinet
03000168	Shelf, 30" W for 19" D cabinet
03000169	Shelf, 36" W for 19" D cabinet
03000170	Shelf, 42" W for 19" D cabinet
03000171	Shelf, 48" W for 19" D cabinet
03000181	Shelf, 12" W for 24" D cabinet
03000184	Shelf, 18" W for 24" D cabinet
03000185	Shelf, 24" W for 24" D cabinet
03000186	Shelf, 30" W for 24" D cabinet
03000187	Shelf, 36" W for 24" D cabinet
03000188	Shelf, 42" W for 24" D cabinet
03000189	Shelf, 48" W for 24" D cabinet
03000525	Shelf, 12" W for add-on cabinet base
03000596	Shelf, 14" W for add-on cabinet base
03000657	Shelf, 18" W for add-on cabinet base
03000791	Shelf, 24" W for add-on cabinet base
03000894	Shelf, 30" W for add-on cabinet base
03000915	Shelf, 36" W for add-on cabinet base
03000927	Shelf, 42" W for add-on cabinet base
03000936	Shelf, 48" W for add-on cabinet base



Pass-Thru Cocktail Stations

More details available. Please visit www.glastender.com

Designed to eliminate wasted steps and save time, the pass-thru cocktail station allows the bartender and cocktail servers to work more efficiently, and able to serve more drinks per hour.

Front and end finish panels to match the existing decor are provided, which hold up the tray shelf and optional single or double overshelves. Laminated panels are available in stainless steel, or any standard laminate color (please specify the manufacturer, color and catalog number when ordering). If you prefer to make your own finish panels, Glastender's specification guide has the drawings and details necessary for fabrication.

Orientation determines the work flow, and is usually dictated by the position of the glasswasher. Counterclockwise: the work flow is right to left with the glasswasher on the left. Clockwise: the work flow is left to right with the glasswasher on the bartender's right.

Cocktail stations are made to order and not returnable.

Part Number	Size"	Rotation	Pass-Thru Ice Bin	Tubing Chase	Wet Waste Sink, Gooseneck Faucet, Strainer	Blender Shelf	Double Speed Rail	12" Wide SS Draining Tray Shelf	15" Wide SS Draining Tray Shelf	8 Bottle Insulated Storage Well	Laminated Front and End Panels
CS42X26CW	42 x 26	CW	X	X	X	X	X	X			X
CS42X26CCW	42 x 26	CCW	X	X	X	X	X	X			X
CS42X26CWS	42 x 26	CW	X	X	X	X	X	X			
CS42X26CCWS	42 x 26	CCW	X	X	X	X	X	X			
CS42X32CW	42 x 32	CW	X	X	2	X	X		X		X
CS42X32CCW	42 x 32	CCW	X	X	2	X	X		X		X
CS42X32CWS	42 x 32	CW	X	X	2	X	X		X		
CS42X32CCWS	42 x 32	CCW	X	X	2	X	X		X		
CS54X32CW	54 x 32	CW	X	X	2	X	X		X	X	X
CS54X32CCW	54 x 32	CCW	X	X	2	X	X		X	X	X
CS54X32CWS	54 x 32	CW	X	X	2	X	X		X	X	
CS54X32CCWS	54 x 32	CCW	X	X	2	X	X		X	X	
CS60X32CW	60 x 32	CW	2	X	2	X	X		X		X
CS60X32CCW	60 x 32	CCW	2	X	2	X	X		X		X
CS60X32CWS	60 x 32	CW	2	X	2	X	X		X		
CS60X32CCWS	60 x 32	CCW	2	X	2	X	X		X		



72" cocktail station, server side



42" cocktail station, bartender side



42" cocktail station, server side



BAR EQUIPMENT



Pass-Thru Cocktail Stations

More details available. Please visit www.glastender.com



CS72CCW with optional SOS,SS72 single overshelf and SG30 sneeze guard



Part Number	Size"	Rotation	GT24 Auto Conveyor Glasswasher	GT30 Auto Conveyor Glasswasher	Wet Waste Sink, Gooseneck Faucet, Strainer	SS Removable Dry Waste Receptacle	Pass-Thru Ice Bin	Tubing Chase	Blender Shelf	Double Speed Rail	12" Wide SS Draining Tray Shelf	15" Wide SS Draining Tray Shelf	8 Bottle Insulated Storage Well	Laminated Front and End Panels
CS42X26GCW	42 x 26	CW	X		X						X			X
CS42X26GCCW	42 x 26	CCW	X		X						X			X
CS42X26GCWS	42 x 26	CW	X		X						X			
CS42X26GCCWS	42 x 26	CCW	X		X						X			
CS42X32GCW	42 x 32	CW	X		2	X					X			X
CS42X32GCCW	42 x 32	CCW	X		2	X					X			X
CS42X32GCWS	42 x 32	CW	X		2	X					X			
CS42X32GCCWS	42 x 32	CCW	X		2	X					X			
CS48X32GCW	48 x 32	CW		X	2							X		X
CS48X32GCCW	48 x 32	CCW		X	2							X		X
CS48X32GCWS	48 x 32	CW		X	2							X		
CS48X32GCCWS	48 x 32	CCW		X	2							X		
CS66X26CW	66 x 26	CW	X		X		X	X	X	X	X			X
CS66X26CCW	66 x 26	CCW	X		X		X	X	X	X	X			X
CS66X26CWS	66 x 26	CW	X		X		X	X	X	X	X			
CS66X26CCWS	66 x 26	CCW	X		X		X	X	X	X	X			
CS66X32CW	66 x 32	CW	X		2	X	X	X	X	X	X			X
CS66X32CCW	66 x 32	CCW	X		2	X	X	X	X	X	X			X
CS66X32CWS	66 x 32	CW	X		2	X	X	X	X	X	X			
CS66X32CCWS	66 x 32	CCW	X		2	X	X	X	X	X	X			
CS72CW	72 x 32	CW		X	2		X	X	X	X		X		X
CS72CCW	72 x 32	CCW		X	2		X	X	X	X		X		X
CS72CWS	72 x 32	CW		X	2		X	X	X	X		X		
CS72CCWS	72 x 32	CCW		X	2		X	X	X	X		X		
CS84CW	84 x 32	CW		X	2		X	X	X	X		X	X	X
CS84CCW	84 x 32	CCW		X	2		X	X	X	X		X	X	X
CS84CWS	84 x 32	CW		X	2		X	X	X	X		X	X	
CS84CCWS	84 x 32	CCW		X	2		X	X	X	X		X	X	

Cocktail stations are made to order and not returnable.



BAR EQUIPMENT



Cocktail Station Accessories

More details available. Please visit www.glastender.com

“SS, not laminate panels” converts laminated front and end panels to stainless steel panels at the factory, and includes foamed-in-place insulation.

Cold plates are built-in to pass-thru ice bin liner at the factory.

Clip-on condiment dispenser clips to either side of station. Clip-on single and double speed rails clip to bartender side. Clip-on dry waste receptacle clips to server side.

Overshelves mount to the end panels, brackets included.

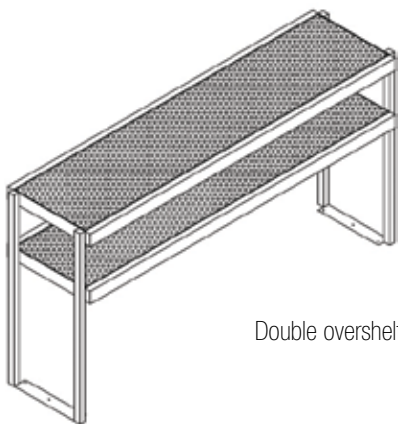

Double overshelf



Condiment dispenser



Clip-on single speed rail



Bolt-on blender shelf

Part Number	Description	CS42X26	CS42X32	CS54X32	CS60X32	CS42X26G	CS42X32G	CS48X32G	CS66X26	CS66X32	CS72	CS84
CPS42X26	SS, not laminate panels	X				X						
CPS42X32	SS, not laminate panels		X				X					
CPS48X32	SS, not laminate panels							X				
CPS54X32	SS, not laminate panels			X								
CPS60X32	SS, not laminate panels				X							
CPS66X26	SS, not laminate panels								X			
CPS66X32	SS, not laminate panels									X		
CPS72X32	SS, not laminate panels										X	
CPS84X32	SS, not laminate panels											X
O2000624	10 circuit cold plate	X				X		X				
O2000626	10 circuit cold plate		X	X	X		X	X		X	X	X
SOS/SS42	42" SS single overshelf	X	X			X	X					
SOS/SS48	48" SS single overshelf							X				
SOS/SS54	54" SS single overshelf			X								
SOS/SS60	60" SS single overshelf				X							
SOS/SS66	66" SS single overshelf								X	X		
SOS/SS72	72" SS single overshelf										X	
SOS/SS84	84" SS single overshelf											X
DOS/SS42	42" SS double overshelf	X	X			X	X					
DOS/SS48	48" SS double overshelf							X				
DOS/SS54	54" SS double overshelf			X								
DOS/SS60	60" SS double overshelf				X							
DOS/SS66	66" SS double overshelf								X	X		
DOS/SS72	72" SS double overshelf										X	
DOS/SS84	84" SS double overshelf											X
IBDHCS26	26"D ice bin divider, half	X				X		X				
IBDHCS32	32"D ice bin divider, half		X	X	X		X	X		X	X	X
CCD/T	Condiment disp, clip-on	X	X	X	X	X	X	X	X	X	X	X
03000508	26"D sneeze guard	X				X		X				
03000509	32"D sneeze guard		X	X	X		X	X		X	X	X
SSR16	16" single speed rail					X	X	X				
CSR16	16" clipon singl speedrail					X	X		X	X		
CSR22	22" clipon singl speedrail							X			X	X
DSR16	16" double speed rail					X	X	X				
CDSR16	16" clip-on dbl speed rail					X	X		X	X		
CDSR22	22" clip-on dbl speed rail							X			X	X
CDRY	SS clip-on dry waste	X	X	X	X	X	X	X	X	X	X	X
BBS16	16" bolt-on blender shelf					X	X	X				

Cocktail stations are made to order and not returnable.



BAR EQUIPMENT



Cocktail Station Accessories

More details available. Please visit www.glastender.com



Part #	Description
EP24	Laminated panel, 26" deep station end panel
EP30	Laminated panel, 32" deep station end panel
FP26	Laminated panel, 54" station front panel (2 required)
FP29	Laminated panel, 60" station front panel (2 required)
FP32	Laminated panel, 66" station front panel (2 required)
FP35	Laminated panel, 72" station front panel (2 required)
FP40	Laminated panel, 42" station front panel
FP41	Laminated panel, 84" station front panel (2 required)
FP46	Laminated panel, 48" station front panel
EP24SS	Stainless steel panel, 26" deep station end panel
EP32SS	Stainless steel panel, 32" deep station end panel
FP26SS	Stainless steel panel, 54" station front panel (2 required)
FP29SS	Stainless steel panel, 60" station front panel (2 required)
FP32SS	Stainless steel panel, 66" station front panel (2 required)
FP35SS	Stainless steel panel, 72" station front panel (2 required)
FP40SS	Stainless steel panel, 42" station front panel
FP41SS	Stainless steel panel, 84" station front panel (2 required)
FP46SS	Stainless steel panel, 48" station front panel
KR42	42" station kick rail
KR48	48" station kick rail
KR54	54" station kick rail
KR60	60" station kick rail
KR66	66" station kick rail
KR72	72" station kick rail
KR84	84" station kick rail
TSC__	12" wide tray shelf, sold in 12" lengths, __ specify length in inches
TSD__	15" wide tray shelf, sold in 12" lengths, __ specify length in inches
TS20X__	20" wide tray shelf, sold in 12" lengths, __ specify length in inches
TSCB	12" tray shelf bracket, set of 2
TSDB	15" tray shelf bracket, set of 2
TR24	Trim rail for GT24 station
TR30	Trim rail for GT30 station
EPC	End panel clips, set of 2
FPC	Front panel clips, set of 2
SOS/SSB*	Single overshelf bracket, set of 2, specify style: EP (end panel), BT (bar top) or WALL
DOS/SSB*	Double overshelf bracket, set of 2, specify style: EP (end panel), BT (bar top) or WALL

Cocktail stations are made to order and not returnable.

Advanced Beverage Solutions • Ph: 877-814-2271 • Fax: 847-524-1710 • E-mail: abscs@absone.com • Visit us online at www.absone.com



GT24 and GT30 Rotary Glasswashers

More details available. Please visit www.glastender.com

A rotary glasswasher is a mechanized three-compartment sink that washes, rinses, and sanitizes glassware up to 11" high automatically. During operation 5 GPM of hot soapy water (130°-150° F) is sprayed in a thorough spray pattern across the moving glassware removing lipstick, dried-on fruit pulp and cream. The wash water is recirculated to conserve water and detergent, consuming only 1/4 GPM of hot water during operation. 3 minute cycle: 60 seconds wash and 60 second rinse.

Features:

- 90 day labor warranty
- Removable top, front and conveyor for easy cleaning
- Set of 3 curtains included
- Switch panel can be relocated in the field
- Removable side panels for easy service
- Automatic peristaltic metering pumps accurately dispense detergent, sanitizer, and rinse aid
- Heater is encased in sheath to resist caustic detergents
- Digital temperature gauge built into switch panel
- Thermostat controlled wash tank
- Sensor activated low water cut off protects heater
- Sensor alerts operator when detergent or sanitizer are low

GT-24 washes up to 13 glasses per minute (800 per hour), and GT-30 washes 21 glasses per minute (1,260 per hour).

2 GPM of 75° F fresh rinse water with sanitizer is pumped in the rinse tank in a thorough spray pattern across the moving glassware. Cool rinse water means no waiting for a glass to cool. The rotary conveyor automatically stops when the clean glass touches the glass stop arm. Removing the glass starts the conveyor. Or, if extremely busy, the glass stop arm can be put aside so starting and stopping is controlled by the conveyor switch.

Rotation selection is based on work flow. If a side mounted switch panel is required, it must be specified when ordering. Please refer to spec sheets for details.

Part #	Length"	Depth"	Rotation	Volts
GT24CW208	24	24	Clockwise	208V
GT24CW240	24	24	Clockwise	240V
GT24CCW208	24	24	Counterclockwise	208V
GT24CCW240	24	24	Counterclockwise	240V
GT30CW208	30	30	Clockwise	208V
GT30CW240	30	30	Clockwise	240V
GT30CCW208	30	30	Counterclockwise	208V
GT30CCW240	30	30	Counterclockwise	240V



GT24



GT30



Stemware rack

Part #	Description
01000557	Export transformer, converts to 220V, 1 phase, 50 Hz
01000828	Mixing valve, mixes hot and cold water to 75° F
CWET24	Clip-on wet waste for GT24
CWET30	Clip-on wet waste for GT30
01000534	Stemware rack for GT24
01000535	Stemware rack for GT30



GT18 Rotary Glasswashers

More details available. Please visit www.glastender.com

There are 10 different GT18 models to select from to optimize your glasswasher throughput. 10 glasses per minute (600 per hour) capacity. Maximum glass height is 10", including pitchers and wine carafes.

Extended GT18+2 models have the drain table extended on one side of the glasswasher to hold more than one rack. This increases overall glasswasher throughput by allowing multiple racks of glassware to be pre-loaded for washing.

78" models come with three racks, and 90" models come with four. A leg set is included under the extended drain table.

Features:

- 90 day labor warranty
- Drive wheel and glass rack lift out for easy cleaning
- Two 16" diameter polypropylene racks are included
- 15 spray nozzles for maximum soil removal
- Automatic peristaltic metering pumps accurately dispense detergent, sanitizer, and rinse aid
- Digital temperature gauge built into switch panel
- Intelligent microprocessor control delays cycle start if incoming water is below 120° F
- Prime switch for quick chemical priming
- Recirculation pump for wash and rinse water
- 2 minute cycle, 70 second wash and 22 second rinse

Part #	Description
01000532	Glass rack
01000533	Dish rack
01000536	Glass rack insert for stemware
01000710	Clip-on chemical rail
01000706	Glass rack holder for GT18+1 only
01000708	Glass rack holder for GT18+2, +1L or 1R models
01000709	Glass rack holder w shelf, GT18+2, +1L or 1R models
01000557	Export transformer, converts to 220V, 1 phase, 50 Hz



GT18+2 with SWA12 wet waste sink and 01000709 glass rack holder

Part #	Description	Length"	Drain Table
GT18	Front load door type	18	N/A
GT18+1	Front-to-back pass thru	18	Back
GT18+1L	Front-to-side pass thru	36	Left
GT18+1R	Front-to-side pass thru	36	Right
GT18+2	Side-to-side pass thru	60	Left & right
GT18+2IC	Side-to-side corner pass thru	42 x 42	Left & right
GT18+278L	Side-to-side pass thru, left extended	78	Left & right
GT18+278R	Side-to-side pass thru, right extended	78	Left & right
GT18+290L	Side-to-side pass thru, left extended	90	Left & right
GT18+290R	Side-to-side pass thru, right extended	90	Left & right



Mug Frosters

More details available. Please visit www.glastender.com

Reach-in mug froster allows diverse glass storage and easy rotation of inventory while matching the look of the back bar coolers. Choose from black vinyl-clad, stainless front and sides, or all stainless. Matching backsplashes are available for a complete, consistent underbar design. All models have stainless steel top, sliding doors and interior, including evaporator housing and evaporator pan. 24" and 36" models have one door, 48" have two doors. Bottom rack is included on all models.

There are two defrost cycles: *automatic* occurs every six hours without affecting normal operation, *manual* is user selected six hour defrost with automatic restart.

Integrated toe kick and curb base mounts flat on all sides to seal to the floor. Condensate drains to an automatic evaporator so no drain connection is required. Condensing unit pulls out, and evaporator housing unplugs and lifts out for easy service. 5 year compressor warranty.

Capacity (based on 10 oz. mugs and 2 layers of shelves):
24" = 105, 36" = 175, 48" = 252.



Part #	Description
C4X4MF	4 casters, 3-3/4"
MFLS	4 legs, 6"
MFKR24	24" kick rail
MFKR36	36" kick rail
MFKR48	48" kick rail
SSR24	24" single speed rail
SSR36	36" single speed rail
SSR48	48" single speed rail
MFBS24	24" backsplash
MFBS36	36" backsplash
MFBS48	48" backsplash
CE220/50S	Convert self contained unit to 220V/50Hz electrical

Dimensions"	Black Vinyl-Clad	Stainless Front & Sides	All Stainless	# of Shelves
24W x 24D x 34.5H	MF24B	MF24SF	MF24S	0
24W x 24D x 34.5H	MF24B1	MF24SF1	MF24S1	1
24W x 24D x 34.5H	MF24B2	MF24SF2	MF24S2	2
36W x 24D x 34.5H	MF36B	MF36SF	MF36S	0
36W x 24D x 34.5H	MF36B1	MF36SF1	MF36S1	1
36W x 24D x 34.5H	MF36B2	MF36SF2	MF36S2	2
48W x 24D x 34.5H	MF48B	MF48SF	MF48S	0
48W x 24D x 34.5H	MF48B1	MF48SF1	MF48S1	1
48W x 24D x 34.5H	MF48B2	MF48SF2	MF48S2	2



Back Bar Refrigeration

More details available. Please visit www.glastender.com

Back bar coolers are available with up to four doors, and as self-contained or remote refrigerated. Coolers have black vinyl-clad steel exterior front and sides, and 180° swinging door. Nine door styles are available to satisfy diverse needs and decor. Edge cap on the laminated doors and compressor compartment covers protect laminate from chipping. Coolers are available without a finished top for integrated installation below a customer supplied bar top. 2008 Energy Star approved (except glass door units).

Unique end wall refrigeration design with evaporator located above the compressor compartment frees up interior space for maximum storage capacity. Recessed compressor compartment back and 90° electrical plug enables flush wall placement. Easy to remove condenser filter can be regularly cleaned to maintain condenser coil efficiency. Automatic and manual defrost cycles prevent ice build-up from impacting operation.

Leg sockets are recessed into the base, and 1/2" thick plastic threshold scuff plate protects lower door sill. Optional leg sets employ a unique recessed cup design to enhance durability. 16 gauge galvanized steel interlocking multi-bend base provides incredible strength and rigidity.

The all stainless steel interior with radius corners is easy to keep clean and meets NSF Standard 7 for open food containers on BB and ND models. Adjustable shelves also have radius corners.

Glass ice displays and lighted liquor displays add functionality as well as visual appeal to the back bar. When mounted on a cooler at the factory, the 16" glass display units (GDU) have a rear deck that raises the lighted liquor display (LLD) above the back of the GDU, and the LLD has a front light channel to help illuminate the GDU (shown below).

The following units are made to order and not returnable: remote narrow door coolers, self-contained and remote low profile coolers, self-contained and remote pass-thru coolers, and front venting coolers.

Model	Long Neck Bottles, Cases	Wine Bottles, 750 ml
BB24	4.6	56
BB36	7	66
BB48	13.83	120
BB60	14	138
BB72	22.5	198
BB84	21.9	216
BB96	30.25	276
BB108	29.8	294
ND40	10.8	102
ND52	12.3	120
ND60	16.9	174
ND72	18.4	192
ND80	22.3	246
ND92	24.5	264





Self-Contained Back Bar Coolers

More details available. Please visit www.glastender.com



BB24-N1GSN(L)

One door self-contained back bar cooler. Available in remote version.



Create a model number by selecting from the options below:

BB24N _ _ _ _ ()

- Base Height:**
1 = 1"
6 = 6" legs
- Door Style:**
B = Black vinyl-clad
U = Unlaminated
L = Laminated
S = Stainless
G = Glass
X = Stainless glass
Y = Laminated glass
- Top Style:**
N = Not finished
L = Laminated
S = Stainless
- Refrigeration:**
N = Self-contained
R = Remote
- Door Hinge:**
L = Left
R = Right
left to right



BB36L1BNH(L)

One door self-contained back bar cooler



BB36 _ _ _ _ **H**(_)

- Refrigeration Compartment:**
L = Left
R = Right
- Base Height:**
1 = 1"
6 = 6" legs
- Door Style:**
B = Black vinyl-clad
U = Unlaminated
L = Laminated
S = Stainless
G = Glass
X = Stainless glass
Y = Laminated glass
- Top Style:**
N = Not finished
L = Laminated
S = Stainless
- Door Hinge:**
L = Left
R = Right
left to right



BB60L1SSHRLR

Two door self-contained back bar cooler



BB60 _ _ _ _ **H**(_ _)

- Refrigeration Compartment:**
L = Left
R = Right
- Base Height:**
1 = 1"
6 = 6" legs
- Door Style:**
B = Black vinyl-clad
U = Unlaminated
L = Laminated
S = Stainless
G = Glass
X = Stainless glass
Y = Laminated glass
- Top Style:**
N = Not finished
L = Laminated
S = Stainless
- Door Hinge:**
L = Left
R = Right
left to right



Self-Contained Back Bar Coolers

More details available. Please visit www.glastender.com



BR60L1XS(LR)

Create a model number by selecting from the options below:

60 ()

- Configuration:**
 - BW = Beer/white wine
 - BR = Beer/red wine
 - WR = White/red wine
- Refrigeration Compartment:**
 - L = Left
 - R = Right
- Base Height:**
 - 1 = 1"
 - 6 = 6" legs
- Door Style:**
 - B = Black vinyl-clad
 - U = Unlaminated
 - L = Laminated
 - S = Stainless
 - G = Glass
 - X = Stainless glass
 - Y = Laminated glass
- Top Style:**
 - N = Not finished
 - L = Laminated
 - S = Stainless
- Door Hinge:**
 - L = Left
 - R = Right
 - left to right*

Dual zone two door self-contained back bar cooler



BB72R1LNN(LRR)

BB84 H()

- Refrigeration Compartment:**
 - L = Left
 - R = Right
- Base Height:**
 - 1 = 1"
 - 6 = 6" legs
- Door Style:**
 - B = Black vinyl-clad
 - U = Unlaminated
 - L = Laminated
 - S = Stainless
 - G = Glass
 - X = Stainless glass
 - Y = Laminated glass
- Top Style:**
 - N = Not finished
 - L = Laminated
 - S = Stainless
- Door Hinge:**
 - L = Left
 - R = Right
 - left to right*

Three door self-contained back bar cooler



Four door self-contained back bar cooler

BB108 H()

- Refrigeration Compartment:**
 - L = Left
 - R = Right
- Base Height:**
 - 1 = 1"
 - 6 = 6" legs
- Door Style:**
 - B = Black vinyl-clad
 - U = Unlaminated
 - L = Laminated
 - S = Stainless
 - G = Glass
 - X = Stainless glass
 - Y = Laminated glass
- Top Style:**
 - N = Not finished
 - L = Laminated
 - S = Stainless
- Door Hinge:**
 - L = Left
 - R = Right
 - left to right*





Self-Contained Narrow Door Back Bar Coolers

More details available. Please visit www.glastender.com

Create a model number by selecting from the options below:



ND52BRL1GS(RL)

Two door self-contained narrow door back bar cooler



ND52 ()

- Refrigeration Compartment:** L = Left, R = Right
- Base Height:** 1 = 1", 6 = 6" legs
- Door Style:** B = Black vinyl-clad, U = Unlaminated, L = Laminated, S = Stainless, G = Glass, X = Stainless glass, Y = Laminated glass
- Top Style:** N = Not finished, L = Laminated, S = Stainless
- Door Hinge:** L = Left, R = Right, *left to right*



ND72R1GS(LRL)

Three door self-contained narrow door back bar cooler



ND72 ()

- Refrigeration Compartment:** L = Left, R = Right
- Base Height:** 1 = 1", 6 = 6" legs
- Door Style:** B = Black vinyl-clad, U = Unlaminated, L = Laminated, S = Stainless, G = Glass, X = Stainless glass, Y = Laminated glass
- Top Style:** N = Not finished, L = Laminated, S = Stainless
- Door Hinge:** L = Left, R = Right, *left to right*

Four door self-contained narrow door back bar cooler

ND92 ()

- Refrigeration Compartment:** L = Left, R = Right
- Base Height:** 1 = 1", 6 = 6" legs
- Door Style:** B = Black vinyl-clad, U = Unlaminated, L = Laminated, S = Stainless, G = Glass, X = Stainless glass, Y = Laminated glass
- Top Style:** N = Not finished, L = Laminated, S = Stainless
- Door Hinge:** L = Left, R = Right, *left to right*



Narrow door coolers are made to order and not returnable.



Remote Back Bar Coolers

More details available. Please visit www.glastender.com

Create a model number by selecting from the options below:

BB48 _____ **N**(_____)

Two door remote back bar cooler

Remote Hook-Up Side:
L = Left
R = Right

Base Height:
1 = 1"
6 = 6" legs

Door Style:
B = Black vinyl-clad
U = Unlaminated
L = Laminated
S = Stainless
G = Glass
X = Stainless glass
Y = Laminated glass

Top Style:
N = Not finished
L = Laminated
S = Stainless

Door Hinge:
L = Left
R = Right
left to right



BB72 _____ **N**(_____)



BB72R1LNN(LLR)

Three door remote back bar cooler

Remote Hook-Up Side:
L = Left
R = Right

Base Height:
1 = 1"
6 = 6" legs

Door Style:
B = Black vinyl-clad
U = Unlaminated
L = Laminated
S = Stainless
G = Glass
X = Stainless glass
Y = Laminated glass

Top Style:
N = Not finished
L = Laminated
S = Stainless

Door Hinge:
L = Left
R = Right
left to right



BB96 _____ **N**(_____)

Four door remote back bar cooler

Remote Hook-Up Side:
L = Left
R = Right

Base Height:
1 = 1"
6 = 6" legs

Door Style:
B = Black vinyl-clad
U = Unlaminated
L = Laminated
S = Stainless
G = Glass
X = Stainless glass
Y = Laminated glass

Top Style:
N = Not finished
L = Laminated
S = Stainless

Door Hinge:
L = Left
R = Right
left to right





Remote Narrow Door Back Bar Coolers

More details available. Please visit www.glastender.com

Create a model number by selecting from the options below:

ND40 ()



ND40R1SSRR

Two door remote narrow door back bar cooler

Remote Hook-Up Side:
L = Left
R = Right

Base Height:
1 = 1"
6 = 6" legs

Door Style:
B = Black vinyl-clad
U = Unlaminated
L = Laminated
S = Stainless
G = Glass
X = Stainless glass
Y = Laminated glass

Top Style:
N = Not finished
L = Laminated
S = Stainless

Door Hinge:
L = Left
R = Right
left to right



ND60 ()



ND60R1SSRRR

Three door remote narrow door back bar cooler

Remote Hook-Up Side:
L = Left
R = Right

Base Height:
1 = 1"
6 = 6" legs

Door Style:
B = Black vinyl-clad
U = Unlaminated
L = Laminated
S = Stainless
G = Glass
X = Stainless glass
Y = Laminated glass

Top Style:
N = Not finished
L = Laminated
S = Stainless

Door Hinge:
L = Left
R = Right
left to right



ND80 ()

Four door remote narrow door back bar cooler

Remote Hook-Up Side:
L = Left
R = Right

Base Height:
1 = 1"
6 = 6" legs

Door Style:
B = Black vinyl-clad
U = Unlaminated
L = Laminated
S = Stainless
G = Glass
X = Stainless glass
Y = Laminated glass

Top Style:
N = Not finished
L = Laminated
S = Stainless

Door Hinge:
L = Left
R = Right
left to right



Narrow door coolers are made to order and not returnable.



Self-Contained Low Profile Back Bar Coolers

More details available. Please visit www.glastender.com

Create a model number by selecting from the options below:



LP60R1SS(LR)

Two door self-contained low profile back bar cooler

LP60 _ _ _ _ (_ _)

- Refrigeration Compartment:**
L = Left
R = Right
- Base Height:**
1 = 1"
6 = 6" legs
- Door Style:**
B = Black vinyl-clad
U = Unlaminated
L = Laminated
S = Stainless
G = Glass
X = Stainless glass
Y = Laminated glass
- Top Style:**
N = Not finished
L = Laminated
S = Stainless
- Door Hinge:**
L = Left
R = Right
left to right

Three door self-contained low profile back bar cooler

LP84 _ _ _ _ (_ _)

- Refrigeration Compartment:**
L = Left
R = Right
- Base Height:**
1 = 1"
6 = 6" legs
- Door Style:**
B = Black vinyl-clad
U = Unlaminated
L = Laminated
S = Stainless
G = Glass
X = Stainless glass
Y = Laminated glass
- Top Style:**
N = Not finished
L = Laminated
S = Stainless
- Door Hinge:**
L = Left
R = Right
left to right

Four door self-contained narrow door back bar cooler

LP108 _ _ _ _ (_ _)

- Refrigeration Compartment:**
L = Left
R = Right
- Base Height:**
1 = 1"
6 = 6" legs
- Door Style:**
B = Black vinyl-clad
U = Unlaminated
L = Laminated
S = Stainless
G = Glass
X = Stainless glass
Y = Laminated glass
- Top Style:**
N = Not finished
L = Laminated
S = Stainless
- Door Hinge:**
L = Left
R = Right
left to right

Low profile coolers are made to order and not returnable.



Remote Low Profile Back Bar Coolers

More details available. Please visit www.glastender.com



LP48L1BL(LR)

Two door remote low profile back bar cooler

Create a model number by selecting from the options below:

LP48 _ _ _ _ (_ _)

- Remote Hook-Up Side:**
L = Left
R = Right
- Base Height:**
1 = 1"
6 = 6" legs
- Door Style:**
B = Black vinyl-clad
U = Unlaminated
L = Laminated
S = Stainless
G = Glass
X = Stainless glass
Y = Laminated glass
- Top Style:**
N = Not finished
L = Laminated
S = Stainless
- Door Hinge:**
L = Left
R = Right
left to right

LP72 _ _ _ _ (_ _)

- Remote Hook-Up Side:**
L = Left
R = Right
- Base Height:**
1 = 1"
6 = 6" legs
- Door Style:**
B = Black vinyl-clad
U = Unlaminated
L = Laminated
S = Stainless
G = Glass
X = Stainless glass
Y = Laminated glass
- Top Style:**
N = Not finished
L = Laminated
S = Stainless
- Door Hinge:**
L = Left
R = Right
left to right

Three door remote low profile back bar cooler

LP96 _ _ _ _ (_ _)

- Remote Hook-Up Side:**
L = Left
R = Right
- Base Height:**
1 = 1"
6 = 6" legs
- Door Style:**
B = Black vinyl-clad
U = Unlaminated
L = Laminated
S = Stainless
G = Glass
X = Stainless glass
Y = Laminated glass
- Top Style:**
N = Not finished
L = Laminated
S = Stainless
- Door Hinge:**
L = Left
R = Right
left to right

Four door remote low profile back bar cooler

Low profile coolers are made to order and not returnable.



Self-Contained Pass-Thru Coolers

More details available. Please visit www.glastender.com



PT60L1LLH(LR/RL)

Four door self-contained pass-thru cooler

Create a model number by selecting from the options below:

PT60 _____ H(_____/_____)

- Refrigeration Compartment:** L = Left, R = Right
determines cooler front
- Base Height:** 1 = 1", 6 = 6" legs
- Door Style:** B = Black vinyl-clad, U = Unlaminated, L = Laminated, S = Stainless, G = Glass, X = Stainless glass, Y = Laminated glass
- Top Style:** N = Not finished, L = Laminated, S = Stainless
- Door Hinge:** L = Left, R = Right
cooler front left to right / cooler back left to right

Six door self-contained pass-thru cooler

PT84 _____ H(_____/_____)

- Refrigeration Compartment:** L = Left, R = Right
determines cooler front
- Base Height:** 1 = 1", 6 = 6" legs
- Door Style:** B = Black vinyl-clad, U = Unlaminated, L = Laminated, S = Stainless, G = Glass, X = Stainless glass, Y = Laminated glass
- Top Style:** N = Not finished, L = Laminated, S = Stainless
- Door Hinge:** L = Left, R = Right
cooler front left to right / cooler back left to right

Eight door self-contained pass-thru cooler

PT108 _____ H(_____/_____)

- Refrigeration Compartment:** L = Left, R = Right
determines cooler front
- Base Height:** 1 = 1", 6 = 6" legs
- Door Style:** B = Black vinyl-clad, U = Unlaminated, L = Laminated, S = Stainless, G = Glass, X = Stainless glass, Y = Laminated glass
- Top Style:** N = Not finished, L = Laminated, S = Stainless
- Door Hinge:** L = Left, R = Right
cooler front left to right / cooler back left to right

Pass-thru coolers are made to order and not returnable.



Remote Pass-Thru Coolers

More details available. Please visit www.glastender.com



Four door remote pass-thru cooler

Create a model number by selecting from the options below:

PT48 _____ **N**(_____ / _____)

Remote Hook-Up

Side:
L = Left
R = Right
determines cooler front

Base Height:

1 = 1"
6 = 6" legs

Door Style:

B = Black vinyl-clad
U = Unlaminated
L = Laminated
S = Stainless
G = Glass
X = Stainless glass
Y = Laminated glass

Top Style:

N = Not finished
L = Laminated
S = Stainless

Door Hinge:

L = Left
R = Right
*cooler front
left to right /
cooler back
left to right*

PT72 _____ **N**(_____ / _____)

Remote Hook-Up

Side:
L = Left
R = Right
determines cooler front

Base Height:

1 = 1"
6 = 6" legs

Door Style:

B = Black vinyl-clad
U = Unlaminated
L = Laminated
S = Stainless
G = Glass
X = Stainless glass
Y = Laminated glass

Top Style:

N = Not finished
L = Laminated
S = Stainless

Door Hinge:

L = Left
R = Right
*cooler front
left to right /
cooler back
left to right*

Six door remote pass-thru cooler

PT96 _____ **N**(_____ / _____)

Remote Hook-Up

Side:
L = Left
R = Right
determines cooler front

Base Height:

1 = 1"
6 = 6" legs

Door Style:

B = Black vinyl-clad
U = Unlaminated
L = Laminated
S = Stainless
G = Glass
X = Stainless glass
Y = Laminated glass

Top Style:

N = Not finished
L = Laminated
S = Stainless

Door Hinge:

L = Left
R = Right
*cooler front
left to right /
cooler back
left to right*

Six door remote pass-thru cooler

Pass-thru coolers are made to order and not returnable.



Front Venting Coolers

More details available. Please visit www.glastender.com

Create a model number by selecting from the options below:



FV24SS(L)

One door self-contained front venting cooler

FV24 _ _ ()

Door Style:

- B = Black vinyl-clad
- U = Unlaminated
- L = Laminated
- S = Stainless
- G = Glass
- X = Stainless glass
- Y = Laminated glass

Top Style:

- N = Not finished
- L = Laminated
- S = Stainless

Door Hinge:

- L = Left
- R = Right



Two door self-contained front venting cooler

FV48 _ _ (LR)

Door Style:

- B = Black vinyl-clad
- U = Unlaminated
- L = Laminated
- S = Stainless
- G = Glass
- X = Stainless glass
- Y = Laminated glass

Top Style:

- N = Not finished
- L = Laminated
- S = Stainless

Door hinging is only available left-right

Self-Contained Reach-In Mug Chiller



MFV24SS(L)

One door self-contained front venting cooler

MFV24 _ _ ()

Door Style:

- B = Black vinyl-clad
- U = Unlaminated
- L = Laminated
- S = Stainless
- G = Glass
- X = Stainless glass
- Y = Laminated glass

Top Style:

- N = Not finished
- L = Laminated
- S = Stainless

Door Hinge:

- L = Left
- R = Right



BAR EQUIPMENT



Slide Top Coolers

More details available. Please visit www.glastender.com



ST60B



ST24S



ST48S

Part #	Description
C4X4ST	3-3/4" casters, set of four
C6X4ST	3-3/4" casters, set of six
STLS4	6" leg set, set of four
STLS6	6" leg set, set of six
BO/CC	Bottle opener/cap catcher
STKR24	24" kick rail
STKR36	36" kick rail
STKR48	48" kick rail
STKR60	60" kick rail
STKR72	72" kick rail
STKR96	96" kick rail
STBS24	24" slide top backsplash
STBS36	36" slide top backsplash
STBS48	48" slide top backsplash
STBS60	60" slide top backsplash
STBS72	72" slide top backsplash
STBS96	96" slide top backsplash
08000082	Chrome divider rack (extra)
CE220/50S	Convert self contained unit to 220V/50Hz electrical

Galvanized Steel Interior with Stainless Steel Floor

Dimensions"	Black Vinyl-Clad	Stainless Front & Sides	All Stainless	Divider Racks	Case Capacity Bottles
24W x 24D x 34.5H	ST24BG	ST24SFG	ST24SG*	1	4.83
36W x 24D x 34.5H	ST36BG	ST36SFG	ST36SG*	2	7.25
48W x 24D x 34.5H	ST48BG	ST48SFG	ST48SG*	3	13.63
60W x 24D x 34.5H	ST60BG	ST60SFG	ST60SG*	4	19.82
72W x 24D x 34.5H	ST72BG	ST72SFG	ST72SG*	4	24.75
96W x 24D x 34.5H	ST96BG	ST96SFG*	ST96SG*	5	32.17

Stainless Steel Interior

*Made to order and not returnable.

Dimensions"	Black Vinyl-Clad	Stainless Front & Sides	All Stainless	Divider Racks	Case Capacity Bottles
24W x 24D x 34.5H	ST24B	ST24SF	ST24S	1	4.83
36W x 24D x 34.5H	ST36B	ST36SF	ST36S	2	7.25
48W x 24D x 34.5H	ST48B	ST48SF	ST48S	3	13.63
60W x 24D x 34.5H	ST60B	ST60SF	ST60S*	4	19.82
72W x 24D x 34.5H	ST72B	ST72SF	ST72S*	4	24.75
96W x 24D x 34.5H	ST96B	ST96SF*	ST96S*	5	32.17

Advanced Beverage Solutions • Ph: 877-814-2271 • Fax: 847-524-1710 • E-mail: abscs@absone.com • Visit us online at www.absone.com



Self-Contained Keg Coolers

More details available. Please visit www.glastender.com



Note: faucet handles are not included

KC24NCBS2R
Shown with optional 2-faucet column tower for use with 1/6 barrel mini kegs

Create a model number by selecting from the options below:

KC24N _ _ S _ (_)

- Base Height:**
1 = 1"
C = 2" casters
6 = 6" legs
- Door Style:**
B = Black vinyl-clad
S = Stainless
- Top Style:**
S = Stainless
- Tower Style:**
1 = 1 faucet
2 = 2 faucet
3 = 3 faucet
- Door Hinge:**
L = Left
R = Right
left to right

Stainless steel top has full length recessed drainer



KC60L1BS(LR)

KC60 _ _ S(_ _)

- Refrigeration Compartment:**
L = Left
R = Right
- Base Height:**
1 = 1"
C = 2" casters
6 = 6" legs
- Door Style:**
B = Black vinyl-clad
S = Stainless
- Top Style:**
S = Stainless
- Door Hinge:**
L = Left
R = Right
left to right

Stainless steel top has full length recessed drainer



KC72L1BS(LR)

KC72 _ _ S(_ _)

- Refrigeration Compartment:**
L = Left
R = Right
- Base Height:**
1 = 1"
C = 2" casters
6 = 6" legs
- Door Style:**
B = Black vinyl-clad
S = Stainless
- Top Style:**
S = Stainless
- Door Hinge:**
L = Left
R = Right
left to right

Stainless steel top has full length recessed drainer

KC84 _ _ S(_ _)

- Refrigeration Compartment:**
L = Left
R = Right
- Base Height:**
1 = 1"
C = 2" casters
6 = 6" legs
- Door Style:**
B = Black vinyl-clad
S = Stainless
- Top Style:**
S = Stainless
- Door Hinge:**
L = Left
R = Right
left to right

Stainless steel top has full length recessed drainer

Three door keg cooler



24" Deep Back Bar Storage Units

Storage units have stainless steel interiors with black vinyl-clad or stainless steel exteriors. Stainless steel or laminated tops are sold separately. Bar liquor display (BLD) features a built-in light for illuminating bottles, radius step edges for easy cleaning, and step covers to reduce bottle noise. Bar glass storage (BGS) has four shelves for maximum storage capacity and radius shelf corners for easy cleaning.

More details available. Please visit www.glastender.com



Description	Black	Stainless	Length"
Bar glass storage	BGS18	BGS18S	18
Bar glass storage	BGS24	BGS24S	24
Bar glass storage	BGS30	BGS30S	30
Bar liquor display	BLD18	BLD18S	18
Bar liquor display	BLD24	BLD24S	24
Bar liquor display	BLD30	BLD30S	30
Bar liquor display	BLD36	BLD36S	36
Bar liquor display	BLD42	BLD42S	42
Bar liquor display	BLD48	BLD48S	48
BLD locking cover	BLC18	BLC18S	18
BLD locking cover	BLC24	BLC24S	24
BLD locking cover	BLC30	BLC30S	30
BLD locking cover	BLC36	BLC36S	36
BLD locking cover	BLC42	BLC42S	42
BLD locking cover	BLC48	BLC48S	48

Description	Laminate	Stainless	Length"
Finished top	TOP18L	TOP18S	18
Finished top	TOP24L	TOP24S	24
Finished top	TOP30L	TOP30S	30
Finished top	TOP36L	TOP36S	36
Finished top	TOP42L	TOP42S	42
Finished top	TOP48L	TOP48S	48
SS kick rail		CKR18	18
SS kick rail		CKR24	24
SS kick rail		CKR30	30
SS kick rail		CKR36	36
SS kick rail		CKR42	42
SS kick rail		CKR48	48
6" legs, set of 4		CLS4	6

Margarita Machine Stand

Interior is galvanized steel with insulation for extra sturdiness. Stainless steel pull handle, and 180° door swing. Top is stainless with 1" high back and side splashes.



Replace the blank () in the part number with R or L for door hinge.

Description	Black	Stainless	Length"
1 door margarita stand	MS20BS()	MS20SS()	20
1 door margarita stand	MS24BS()	MS24SS()	24
2 door margarita stand	MS44BS()	MS44SS()	44
2 door margarita stand	MS48BS()	MS48SS()	48

Condensing Unit Storage Cabinet



Create a model number:
CS18N **N**

Base Height:
1 = 1"
6 = 6" legs

Front Finish:
B = Black vinyl-clad
S = Stainless

Top Style:
N = Not finished
L = Laminated
S = Stainless



Dry Storage Cabinets

More details available. Please visit www.glastender.com



LPDS241BLR
Low profile dry storage cabinet



DS241BSR
One door dry storage cabinet

Create a model number by selecting from the options below:

LPDS24 _ _ _ _ (_)

- Base Height:**
1 = 1"
6 = 6" legs
- Door Style:**
B = Black vinyl-clad
U = Unlaminated
L = Laminated
S = Stainless
- Top Style:**
N = No finish
L = Laminate
S = Stainless
- Door Hinge:**
L = Left
R = Right
left to right

DS24N _ _ _ _ (_)

- Base Height:**
1 = 1"
6 = 6" legs
- Door Style:**
B = Black vinyl-clad
U = Unlaminated
L = Laminated
S = Stainless
- Top Style:**
N = No finish
L = Laminate
S = Stainless
- Door Hinge:**
L = Left
R = Right
left to right

Two door dry storage cabinet

DS48N _ _ _ _ **N**(_ _)

- Base Height:**
1 = 1"
6 = 6" legs
- Door Style:**
B = Black vinyl-clad
U = Unlaminated
L = Laminated
S = Stainless
- Top Style:**
N = No finish
L = Laminate
S = Stainless
- Door Hinge:**
L = Left
R = Right
left to right

Three door dry storage cabinet

DS72N _ _ _ _ **N**(_ _ _)

- Base Height:**
1 = 1"
6 = 6" legs
- Door Style:**
B = Black vinyl-clad
U = Unlaminated
L = Laminated
S = Stainless
- Top Style:**
N = No finish
L = Laminate
S = Stainless
- Door Hinge:**
L = Left
R = Right
left to right

Part #	Description
DHPBU	Upgrade to brass handle
CKR24	24" kick rail
CKR48	48" kick rail
CKR72	72" kick rail
CKRL	Left side kick rail
CKRR	Right side kick rail
SL/LPL	Left side lamination, LPDS24
SL/LPR	Right side lamination, LPDS24
SLL	Left side lamination, DS
SLR	Right side lamination, DS
SS/LPL	Left side stainless steel, LPDS24
SS/LPR	Right side stainless steel, LPDS24
SSL	Left side stainless steel, DS
SSR	Right side stainless steel, DS
C4X4CO	4" casters, set of four, LPDS24
C6X4CO	4" casters, set of six, DS



Cooler Accessories

More details available. Please visit www.glastender.com



Back bar coolers can be converted to draft beer dispensing and are available with many accessories. The BB84 model shown has two doors converted to draft beer dispensing and a two-faucet column tower. Other accessories include raised panel wood doors, laminated finished top, ice display unit, and lighted liquor display.

Part #	Description
DHPBU	Upgrade to brass handle
CKR24	24" kick rail
CKR36	36" kick rail
CKR40	40" kick rail
CKR48	48" kick rail
CKR52	52" kick rail
CKR60	60" kick rail
CKR72	72" kick rail
CKR80	80" kick rail
CKR84	84" kick rail
CKR92	92" kick rail
CKR96	96" kick rail
CKR108	108" kick rail
CKRL	Left side kick rail
CKRR	Right side kick rail

Part #	Description
SLL	Left side lamination
SLR	Right side lamination
SSL	Left side stainless steel
SSR	Right side stainless steel
C4X4CO	4" casters, set of four, BB24, BB60, ND52, LP60, PT60, KC60
C5X4CO	4" casters, set of five, BB36
C6X4CO	4" casters, set of six, BB84, BB108, ND72, ND92, LP84, LP108, PT84, PT108, KC72, KC84
CBS/SS48	48" stainless backsplash for low profile cooler
CBS/SS60	60" stainless backsplash for low profile cooler
CBS/SS72	72" stainless backsplash for low profile cooler
CBS/SS84	84" stainless backsplash for low profile cooler
CBS/SS96	96" stainless backsplash for low profile cooler
CBS/SS108	108" stainless backsplash for low profile cooler
CE220/50S	Convert self contained unit to 220V/50Hz electrical



Ice Display Units

Ice display units (IDU) can be factory mounted to the top of Back Bar, Narrow Door, Low Profile, Pass-Thru, Front Venting, and Rear Feed Coolers and Dry Storage Cabinets. IDUs are 7" high with 6" deep liner, 1/2" tall perforated bottom insert, and all stainless steel construction. Insulation and a breaker strip around the ice bin provide a thermal barrier. Stainless steel front, back and sides are standard; black vinyl-clad is optional.

Glass ice display units (GDU) have double pane glass front and back with stainless steel trim, perforated insert and insulated end panels. Units larger than 54" include a center partition. Factory installed ice displays include a special stainless steel 1.5" high (not the standard 1" high) insulated cooler top with a built-in drain pan. Field installed units include a stainless steel insulated drain pan to mount to an existing countertop.

All ice displays are made to order and not returnable.

More details available. Please visit www.glastender.com

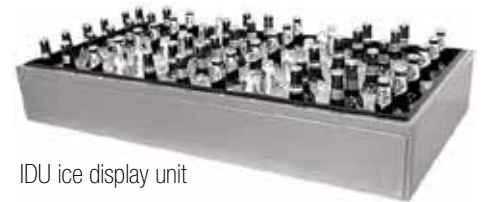

IDU ice display unit



Factory installed GDU on 1.5" high insulated cooler top (not std 1" high) with built-in drain pan

Part #	Dimensions"	Part #	Dimensions"	Part #	Dimensions"	Part #	Dimensions"
IDU12X24	12D x 24L x 7H	IDU18X72	18D x 72L x 7H	GDU12X24	12D x 24L x 7H	GDU18X72	18D x 72L x 7H
IDU12X30	12D x 30L x 7H	IDU18X78	18D x 78L x 7H	GDU12X30	12D x 30L x 7H	GDU18X78	18D x 78L x 7H
IDU12X36	12D x 36L x 7H	IDU18X84	18D x 84L x 7H	GDU12X36	12D x 36L x 7H	GDU18X84	18D x 84L x 7H
IDU12X42	12D x 42L x 7H	IDU18X90	18D x 90L x 7H	GDU12X42	12D x 42L x 7H	GDU18X90	18D x 90L x 7H
IDU12X48	12D x 48L x 7H	IDU18X96	18D x 96L x 7H	GDU12X48	12D x 48L x 7H	GDU18X96	18D x 96L x 7H
IDU12X54	12D x 54L x 7H	IDU18X102	18D x 102L x 7H	GDU12X54	12D x 54L x 7H	GDU18X102	18D x 102L x 7H
IDU12X60	12D x 60L x 7H	IDU18X108	18D x 108L x 7H	GDU12X60	12D x 60L x 7H	GDU18X108	18D x 108L x 7H
IDU12X66	12D x 66L x 7H	IDU24X24	24D x 24L x 7H	GDU12X66	12D x 66L x 7H	GDU24X24	24D x 24L x 7H
IDU12X72	12D x 72L x 7H	IDU24X30	24D x 30L x 7H	GDU12X72	12D x 72L x 7H	GDU24X30	24D x 30L x 7H
IDU12X78	12D x 78L x 7H	IDU24X36	24D x 36L x 7H	GDU12X78	12D x 78L x 7H	GDU24X36	24D x 36L x 7H
IDU12X84	12D x 84L x 7H	IDU24X42	24D x 42L x 7H	GDU12X84	12D x 84L x 7H	GDU24X42	24D x 42L x 7H
IDU12X90	12D x 90L x 7H	IDU24X48	24D x 48L x 7H	GDU12X90	12D x 90L x 7H	GDU24X48	24D x 48L x 7H
IDU12X96	12D x 96L x 7H	IDU24X54	24D x 54L x 7H	GDU12X96	12D x 96L x 7H	GDU24X54	24D x 54L x 7H
IDU12X102	12D x 102L x 7H	IDU24X60	24D x 60L x 7H	GDU12X102	12D x 102L x 7H	GDU24X60	24D x 60L x 7H
IDU12X108	12D x 108L x 7H	IDU24X66	24D x 66L x 7H	GDU12X108	12D x 108L x 7H	GDU24X66	24D x 66L x 7H
IDU18X24	18D x 24L x 7H	IDU24X72	24D x 72L x 7H	GDU18X24	18D x 24L x 7H	GDU24X72	24D x 72L x 7H
IDU18X30	18D x 30L x 7H	IDU24X78	24D x 78L x 7H	GDU18X30	18D x 30L x 7H	GDU24X78	24D x 78L x 7H
IDU18X36	18D x 36L x 7H	IDU24X84	24D x 84L x 7H	GDU18X36	18D x 36L x 7H	GDU24X84	24D x 84L x 7H
IDU18X42	18D x 42L x 7H	IDU24X90	24D x 90L x 7H	GDU18X42	18D x 42L x 7H	GDU24X90	24D x 90L x 7H
IDU18X48	18D x 48L x 7H	IDU24X96	24D x 96L x 7H	GDU18X48	18D x 48L x 7H	GDU24X96	24D x 96L x 7H
IDU18X54	18D x 54L x 7H	IDU24X102	24D x 102L x 7H	GDU18X54	18D x 54L x 7H	GDU24X102	24D x 102L x 7H
IDU18X60	18D x 60L x 7H	IDU24X108	24D x 108L x 7H	GDU18X60	18D x 60L x 7H	GDU24X108	24D x 108L x 7H
IDU18X66	18D x 66L x 7H			GDU18X66	18D x 66L x 7H		



More details available. Please visit www.glastender.com

Lighted Liquor Displays

Lighted liquor displays (LLD) have illuminated 4" high and 4" deep steps with black vinyl-clad exterior, clear acrylic step cover, on/off switch, grounded cord and plug, and removable top for easy access to fluorescent light bulbs (included).

All ice displays are made to order and not returnable.

R or L part number suffix designates power cord position.

Glass display unit lighted liquor displays are taller than standard lighted liquor displays. The first step is 9.25" high to raise the bottles above the glass display unit, and it has a front light channel to help illuminate the GDU to add visual appeal. When mounted on a cooler at the factory, the 16" deep GDU models have a 8.25" rear deck space designed to fit the 8" deep LLD.



Factory mounted LLD behind glass display unit (GDU)



LLDS



LLD3



LLD

Two Tier Displays

Part #	Part #	Dimensions"
LLDS24L	LLDS24R	24L x 8D x 8H
LLDS30L	LLDS30R	30L x 8D x 8H
LLDS36L	LLDS36R	36L x 8D x 8H
LLDS42L	LLDS42R	42L x 8D x 8H
LLDS48L	LLDS48R	48L x 8D x 8H
LLDS54L	LLDS54R	54L x 8D x 8H
LLDS60L	LLDS60R	60L x 8D x 8H
LLDS66L	LLDS66R	66L x 8D x 8H
LLDS72L	LLDS72R	72L x 8D x 8H
LLDS78L	LLDS78R	78L x 8D x 8H
LLDS84L	LLDS84R	84L x 8D x 8H
LLDS90L	LLDS90R	90L x 8D x 8H
LLDS96L	LLDS96R	96L x 8D x 8H
LLDS102L	LLDS102R	102L x 8D x 8H
LLDS108L	LLDS108R	108L x 8D x 8H

Three Tier Displays

Part #	Part #	Dimensions"
LLD324L	LLD324R	24L x 8D x 12H
LLD330L	LLD330R	30L x 8D x 12H
LLD336L	LLD336R	36L x 8D x 12H
LLD342L	LLD342R	42L x 8D x 12H
LLD348L	LLD348R	48L x 8D x 12H
LLD354L	LLD354R	54L x 8D x 12H
LLD360L	LLD360R	60L x 8D x 12H
LLD366L	LLD366R	66L x 8D x 12H
LLD372L	LLD372R	72L x 8D x 12H
LLD378L	LLD378R	78L x 8D x 12H
LLD384L	LLD384R	84L x 8D x 12H
LLD390L	LLD390R	90L x 8D x 12H
LLD396L	LLD396R	96L x 8D x 12H
LLD3102L	LLD3102R	102L x 8D x 12H
LLD3108L	LLD3108R	108L x 8D x 12H

GDU Two Tier Displays

Part #	Part #	Dimensions"
LLD24L	LLD24R	24L x 8D x 13H
LLD30L	LLD30R	30L x 8D x 13H
LLD36L	LLD36R	36L x 8D x 13H
LLD42L	LLD42R	42L x 8D x 13H
LLD48L	LLD48R	48L x 8D x 13H
LLD54L	LLD54R	54L x 8D x 13H
LLD60L	LLD60R	60L x 8D x 13H
LLD66L	LLD66R	66L x 8D x 13H
LLD72L	LLD72R	72L x 8D x 13H
LLD78L	LLD78R	78L x 8D x 13H
LLD84L	LLD84R	84L x 8D x 13H
LLD90L	LLD90R	90L x 8D x 13H
LLD96L	LLD96R	96L x 8D x 13H
LLD102L	LLD102R	102L x 8D x 13H
LLD108L	LLD108R	108L x 8D x 13H



BAR EQUIPMENT



Back Bar and Underbar Miscellaneous

More details available. Please visit www.glastender.com



Back bar cash register



WRACK22



06003690



BO/CC



06001404 shelf divider

Part #	Description
06001419	Lighting, plug-in fluorescent light
06001425	Lighting, GE #F6T5 fluorescent light bulb
06001431	Lighting, rope light kit for BB24, BB36
06001432	Lighting, rope light kit BB60, ND48, ND52, LPT36
06001433	Lighting, rope light kit for BB84, ND72
06001434	Lighting, rope light kit for BB108
STLK1	Light kit for 1 mullion: ST48, ST60
STLK2	Light kit for 2 mullions: ST72, ST96
BBCR	Back bar cash register recess with locking drawer, fits between two adjoining self-contained back bar low profile coolers, 24" L x 24-7/8"
WRACK18	Wine racks, 2, for 18-1/16" shelf (not included)
WRACK20	Wine racks, 2, for 20-1/8" shelf (not included)
WRACK22	Wine racks, 2, for 23-7/8" shelf (not included)
06003690	Wine rack shelf, SS, slots for 9 bottles for 24" door
06003938	Wine rack shelf, SS, slots for 7 bottles for 20" door
06000041	Keg rack, SS, KC24
06001608	Keg rack, SS, BB & ND middle
06001609	Keg rack, SS, BB middle
06001610	Keg rack, SS, ND end
06000042	Keg rack, SS, PT end
06000043	Keg rack, SS, PT middle
BO	Bottle opener
CC	Cap catcher
BO/CC	Bottle opener & cap catcher

Part #	Description
06001654	Glass ice display panel, left, 12" GDU
06001655	Glass ice display panel, right, 12" GDU
06001411	Glass ice display panel, middle, 12" GDU
06001657	Glass ice display panel, left, 16" GDU
06001658	Glass ice display panel, right, 16" GDU
06001656	Glass ice display panel, middle, 16" GDU
06000044	Glass ice display panel, left, 18" GDU
06000045	Glass ice display panel, right, 18" GDU
06000352	Glass ice display panel, middle, 18" GDU
06001662	Glass ice display panel, left, 24" GDU
06001663	Glass ice display panel, right, 24" GDU
06001660	Glass ice display panel, middle, 24" GDU
06001661	Glass ice display panel, front, 24"
06001659	Glass ice display panel, back, 24"
06001665	Glass ice display panel, front, 30"
06001664	Glass ice display panel, back, 30"
06001667	Glass ice display panel, front, 36"
06001666	Glass ice display panel, back, 36"
06001669	Glass ice display panel, front, 42"
06001668	Glass ice display panel, back, 42"
06001674	Glass ice display panel, front, 48"
06001670	Glass ice display panel, back, 48"
06001672	Glass ice display panel, front, 54"
06001671	Glass ice display panel, back, 54"



Back Bar Refrigeration Parts and Accessories

More details available. Please visit www.glastender.com

Part #	Description
06004055	Condensing unit, 1/3 HP R134a, use within 25' of 1 remote cooler with 4 doors or less
06004054	Condensing unit, 1/2 HP R134a, use within 25' of 2 remote cooler with 6 doors or less
06001541	Condensing unit field installation kit for 2 remote units on 1 condensing unit: 1 filter dryer, 1 sight glass, 2 solenoids with 120V coils, 1 pressure control
06001542	Condensing unit field installation kit for 1 remote unit on 1 condensing unit: 1 filter dryer, 1 sight glass
06001589	Condensing unit solenoid (coil required)
06001590	Condensing unit coil (solenoid required)
CROSSRR	Crossover tube assy w 100 CFM blower motor from one refrigerator to another, 30"
CROSSWR	Crossover tube assy w 100 CFM blower motor from a walk-in cooler to refrigerator, 30"
CROSSWT	Crossover tube assy w 100 CFM blower motor from a walk-in cooler to wall mount tower, 30"
SHAFTRT	Air shaft assy w 100 CFM blower motor from refrigerator to beer tower, 72"
SHAFTWT	Air shaft assy w 100 CFM blower motor from walk-in cooler to beer tower, 72"
06001446	Blower motor, 15 CFM
06001447	Blower motor, 60 CFM
06001450	Blower motor, 100 CFM
06001547	Replacement clip for mounting kick rail to leg
CLEG	Replacement leg, 6"
06001560	Caster, swivel, 2.5" high
06001561	Caster, swivel w lock, 2.5" high
06001568	Caster, swivel, 3.75" high
06001559	Caster, swivel w lock, 3.75" high
06001566	Caster, swivel, 5" high
06001567	Caster, swivel w lock, 5" high
06001557	Pilaster
06001565	Clip, SS for pilaster
06001574	Thumb screw, SS for pilaster
00000018	Nut, acorn, 8/32" natural nylon

Part #	Description
06001399	Shelf, vinyl-coated, 18-7/8" x 20-1/8", fits BB24, BB36, FV24, ND72 middle door, end of remote PT
06001400	Shelf, vinyl-coated w corner notch, 18-7/8" x 22-1/16", fits end doors on BB, LP, both FV48 doors
06001401	Shelf, vinyl-coated, 18-7/8" x 23-7/8", fits middle doors on BB, LP, PT and RF models
06001402	Shelf, vinyl-coated, 18-7/8" x 18-1/16", fits end doors on ND models
06001403	Shelf, vinyl-coated, 18-7/8" x 22-1/16", fits end doors on PT and RF models
06001404	Shelf divider
06001281	Shelf, SS, fits BGS18
06001282	Shelf, SS, fits BGS24
06001283	Shelf, SS, fits BGS30
06001284	Shelf angle for BGS
06001278	Shelving floor, SS, fits BGS18
06001279	Shelving floor, SS, fits BGS24
06001280	Shelving floor, SS, fits BGS30
06001195	Shelf, galvanized, fits DS24
06000169	Shelf, galvanized, DS48, DS72 end door
06000170	Shelf, galvanized, DS72 middle door
CBS/SS_	SS backsplash, _ specify needed length in inches
CBS/SSL	SS side splash, left, 4"
CBS/SSR	SS side splash, right, 4"
SB24	SS back upgrade for 24" cooler
SB36	SS back upgrade for 36" cooler
SB48	SS back upgrade for 48" cooler
SB52	SS back upgrade for 52" cooler
SB60	SS back upgrade for 60" cooler
SB72	SS back upgrade for 72" cooler
SB84	SS back upgrade for 84" cooler
SB96	SS back upgrade for 96" cooler
SB108	SS back upgrade for 108" cooler
02000614	Drain screen for IDU, GDU



06001565



06001574



Cleaners and Cleaning Equipment

Liquid sugar below 75° F forms sugar crystals. Syrup and juice sugar crystals build up and impair the performance of beverage dispensers, bag-in-box adapters, pumps, circulating coils, valves, mixing chambers and nozzles. Micro-organisms grow in any area exposed to sugar, water and air and can flush into drinks. Over time moving parts with sugar crystal and bacteria build-up fail to work properly and affect the quality of the drink.

Without Cleaning

- Quality suffers, customers are dissatisfied, drinks are often repoured or discarded, profits decrease
- Syrup or juice concentrate can be mistakenly blamed for poor quality and good boxes of syrup or concentrate are returned or discarded
- Dispensing may be stopped depending on the severity of the problem, and service agents may not be able to respond quickly
- Brush cleaning will help but cannot reach all build-up areas
- Brix is sometimes recalibrated to compensate for the poor performance, creating a temporary fix

With Regular Cleaning

- Consistent quality drinks are poured and customers are satisfied, profits increase
- Sugar crystals and bacteria are removed from the entire system, including areas brush cleaning can't reach
- Flow controls and metering stems operate at optimum performance
- BevClean's inhibitor prevents growth and deposits for 60-90 days after cleaning
- Cleaning time is scheduled during off hours
- Service calls are reduced; replacement parts and labor costs decrease

U.S. Dept. of Health and Human Services, Public Health Service, FDA 2001 Food Code Cleaning Requirement, updated April 2004:

4-701.10 Sanitization of Equipment and Utensils:

"Equipment food-contact surfaces and utensils shall be sanitized."

4-601.11(C) Cleaning of Equipment and Utensils:

"Non-food contact surfaces of equipment shall be kept free of an accumulation of dust, dirt, food residue, and other debris."

4-602.11 (E-4) Cleaning Frequency:

"In equipment such as ice bins and beverage dispensing nozzles and enclosed components of equipment such as ice makers ... beverage and syrup dispensing lines or tubes ... and water vending equipment:

- (a) At a frequency specified by the manufacturer, or
- (b) Absent manufacturer specifications, at a frequency necessary to preclude accumulation of soil or mold."

BevClean™ No Rinse Bag-in-Box Beverage System Cleaner



Cleans everything from the rack to the dispensing point, one line at a time, or up to 8 lines at a time with the BevClean manifold.



BevClean manifold assembled

No More buckets, mixing, waiting for powders to dissolve in the correct temperature of water, waiting for the cleaner to work and then flushing, which can take up to 1 hour per line.

Simply hook the bag connector to the BevClean BIB box, open the dispensing valve until clear BevClean is detected, re-attach the syrup BIB and dispense until the line is full of syrup again. With the manifold assembly you can clean up to 8 lines simultaneously in 15-20 minutes!

BevClean works on contact, is completely safe, leaves no residuals, and inhibits growth and deposits for 60-90 days after cleaning.

Before and After Cleaning





Cleaners and Cleaning Equipment

Assembled BevClean Manifold with CC Adapters

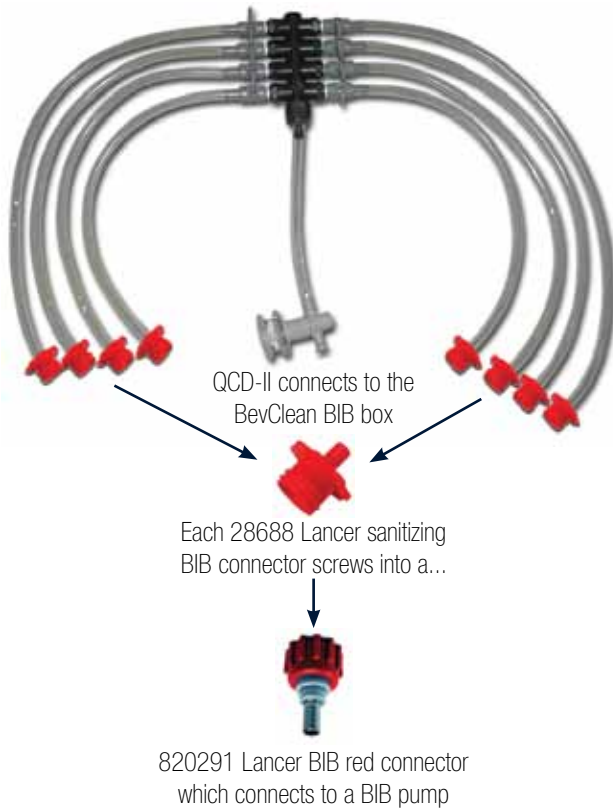

Assembled BevClean Manifold with GB Adapters



There are multiple GB connection options. Please specify which adapters and connectors you need.



Each 33235 Encore fitment valve connects to a...



33230 Encore connector which connects to a BIB pump

OR



Each 33019 Liqui-Box flush adapter connects to one of these...



QCD-II, PCS or PCSS BIB connector which connects to a BIB pump

Part #	Description
216578	BevClean BIB cleaner, 3 gallon box
219000	BevClean BIB cleaner, 55 gallon drum
216701	WinterBev solution, 5 gallons
LCMC-CC	Sanitizing manifold kit with CC adapters
LCM8-LIQUIBOX	Sanitizing manifold kit with GB adapters, please specify which adapters: QCD-II, PCS, PCSS or Encore
146529	BevClean manifold only
33019	Liqui-Box flush adapter
33020	Liqui-Box QCD-II connector
050501501A	Raypak PCS connector - new style
050900901A	Raypak PCSS connector - old style
33230	Encore connector
33235	Encore fitment valve
28688	Lancer sanitizing BIB adapter
820291	Lancer BIB red connector, 3/8"
17.0706R	Oetiker stepless clamp, SS
2000610x100	Tubing, clear BIB PVC, 3/8" x 5/8", 100'

Each CC and GB kit contains a BevClean manifold, 1 QCD-II connector, 8 sanitizing/flush adapters, 8 BIB connectors, 18 Oetiker stepless clamps and 50' of clear PVC BIB tubing to create a manifold assembly as shown above.



WinterBev is a beverage system antifreeze (propylene glycol base) packaged in 5 gallon BIB boxes, ideal for seasonal equipment, or equipment in cold storage. Protects to -11° F. Available in stronger concentrate for extreme low temperatures.



BAR EQUIPMENT

Cleaners and Cleaning Equipment



1842: 1 quart cleaning kit includes 1841 cleaner, 905W 3/4" faucet brush, 904A 3/16" ID hose brush, 4350 faucet coupling nut, spanner wrench, BLC cleaning solution, Draft Beer booklet, ball lifter, and FT584 pump

1844: 2 quart cleaning kit has the same contents as 1842.



8005913289



C157



C360



905W



C237



C148



C169



C170



C248



902



4352



4353



C156



FT85117



FT108



FT110AB



FT874C



C187



FT109S



FT116 & FT8612



FT101L



FT938



C123

Part #	Description
1842	1 qt. cleaning kit with FT584 pump
1844	2 qt. cleaning kit with FT584 pump
8005913289	Electric pump, beer cleaning system
C157	Faucet cleaning jumper hose assembly, 2.5' long
1032	Nozzle brush
220017	Brush, valve nozzle
904A	Hose brush, 3/16" x 66" long
904B	Hose brush, 1/4" x 66" long
904C	Hose brush, 3/8" x 66" long
905W	Faucet brush, nylon, 3/4" x 3" x 8-1/2" long
C237	Faucet and shank brush, double sided
C360	Glass rinser assembly for drip tray
C148	Jet Carboy bottle washer
C169	Carboy handle, 5 gallon
C170	Carboy handle, 6.5 gallon
C248	Faucet adapter for Jet Carboy washer
902	Duplex cleaning coupler
4352	Cleaning attachment, nickel plated, use with #901 or #901R slip coupling
4352T	Same as 4352 but with male beer thread on spout
4353	Cleaning attachment, 5/16" barb
C156	Faucet and shank cleaning attachment
FT115BA	Series cleaning adapter
FT85117	Keg coupler check ball lifter
FT108	Single flusher for single hole keg valve taps
FT110AB	Double flusher for single hole keg valve taps
FT109S	Double flusher adaptor. Beer thread ends permit 2 single flushers to be coupled to form a double flusher
FT874C	Cap and washer, used on male beer thread end of a single flusher to convert to series tap cleaning
FT101L	Probe lubricant, tasteless and odorless, 1 oz. tin, use sparingly after cleaning
FT938	Probe lubricant, tasteless and odorless, 8 oz. tin
FT8612	Wrench, probe and beer hex nut
FT116	Wrench for Taprite and Perlick probes
C123	Wrench, faucet
C187	Wrench, faucet



BAR EQUIPMENT

Cleaners and Cleaning Equipment

Beer line cleaner is sold in case quantities, 12 bottles per case. Price breaks for 2-5 cases, 6-20 cases, and 21 or more cases.

Hazardous material shipping charges apply when shipping UPS, FedEx, or LTL.



1055389

107035
24041

19065312

39619

39617
39618

Part #	Description
1055389	ScaleKleen deliming cleaner, 7 oz., 24 packs/case
107035	Kay-5 sanitizer, 10 lbs., 160 packets
24041	Kay-5 sanitizer, 8 packets, each 1 oz.
19065312	Clear 1 ice machine scale remover, 16 oz.
428734	Ice machine cleaner, 16 oz.
39617	Drafter beer line cleaner, clear, 32 oz., case of 12
39620	Drafter beer line cleaner, clear, 50 gal. drum
39619	Drafter beer line cleaner, blue, 32 oz., case of 12
39622	Drafter beer line cleaner, blue, 50 gal. drum
39618	Drafter beer line cleaner, acid, 32 oz., case of 12
39621	Drafter beer line cleaner, acid, 50 gal. drum

The diagrams on pages 1-4 are courtesy of Micro Matic USA, Inc., Northridge, California.

Glastender is a registered trademark of Glastender, Inc., Saginaw, Michigan.

Wunder-Bar is a registered trademark of Automatic Bar Controls, Inc., Vacaville, California.

Flojet is a registered trademark of ITT Industries, Foothill Ranch, California.

SHURflo is a registered trademark of SHURflo, LLC, Cypress, California.

Taprite is a registered trademark of Taprite-Fassco Mfg., Inc., San Antonio, Texas.

Catalina Cylinders is a registered trademark of Catalina Cylinders, Inc., Garden Grove, California.

Analog 50 and Aspida are registered trademarks of Analog Sensor Technology Inc., Huntington Beach, California.

Thomas is a registered trademark of Gardner Denver Thomas, Inc., Sheboygan, Wisconsin.

Trumix is a registered trademark of McDantim Gas Blending Technologies, Helena, Montana.

Bev-Seal Ultra is registered trademarks of Kuriyama of America, Inc., Elk Grove, Illinois.

Flo-Guard is a registered trademark of Arrow Hose & Tubing, Inc., Guelph, Ontario, Canada, an Eaton Corporation company. Synflex Taste-Rite is a registered trademark of Eaton Corporation, Cleveland, Ohio. Some photography is used with permission of the Eaton Corporation.

Oetiker is a registered trademark of Oetiker International, Marlette, Michigan.

BevClean is a registered trademark of Very Fresh Juice Company, Dayton, Ohio.

Stow 'N Go, ProLatch, StowAway and Lockjaw are trademarks of Plano Molding Company, Plano, Illinois.

Miscellaneous



Cocktail shaker

Jigger

Cocktail shaker



C775



C776



C572



C570



C777



C571



C573



C162



C165 & C171

Part #	Description
C160	Cocktail shaker, 200 ml
C197	Cocktail shaker, 250 ml
C198	Cocktail shaker, 300 ml
C199	Cocktail shaker, 400 ml
C161	Cocktail shaker, 500 ml
C551	SS jigger, one side 1 oz, other side 1/2 oz
C552	SS jigger, one side 1 oz, other side 2 oz
C561	SS ice bucket with lid, dbl wall, 1.5 litre capacity
C775	Sink mounted single touch spout
C777	Wall mounted single touch spout
C776	Single touch aerator, saves water, saves time
C573	SS bottle cap catcher, wall mount
C570	Hand held bottle opener, chrome w vinyl grip
C571	Wall mount bottle opener, SS brushed or polished
C572	Wall mount bottle opener, premium, SS polished
C162	Wine agitating rod, removes gas during wine making
C165	Wine racking cane, SS, 3/8" OD x 30"
C171	Wine racking cane, SS, 3/8" OD x 24"
C166	Replacement tip for 3/8" racking cane



BAR EQUIPMENT

Installer Order Checklist

Qty	Description	Item #	Price	Comments
	Tower 1			
	Tower 2			
	Tower 3			
	Tap handles			
	Drip tray 1			
	Drip tray 2			
	Drip tray 3			
	Shanks			
	Bar guns			
	Liquor portion control system			
	Frozen drink maker			
	Couplers/taps			
	Beer pumps			
	Flow reversal valve			
	FOB/empty keg detector			
	Cold plates			
	Cooling coil			
	Cold block			
	Glycol chiller			
	Chiller stand			
	Chiller wall shelf			
	Glycol			
	Air compressor			
	Gas blender			
	Air distributor			
	CO ₂ tanks			
	CO ₂ tank rack			
	CO ₂ detector/alarm			
	Regulator panel			
	Primary regulators			
	Secondary regulators			
	Nitrogen regulator			
	Bundled tubing			
	Single line tubing			
	Tubing cutter & pincer			
	Tubing hanger brackets			
	Tape			
	Cable ties			
	Stepless clamps			

Advanced Beverage Solutions • Ph: 877-814-2271 • Fax: 847-524-1710 • E-mail: abscs@absone.com • Visit us online at www.absone.com



BAR EQUIPMENT

Installer Order Checklist

Qty	Description	Item #	Price	Comments
	Ice chest/bin			
	Blender station			
	Underbar drainboard			
	Underbar glass rack			
	Underbar glass cabinet			
	Underbar glass washer			
	Underbar sink			
	Underbar beer drainer			
	Underbar liquor display			
	Underbar dry waste			
	Underbar all-in-one station			
	Underbar drink rail			
	Underbar speed rail			
	Underbar bar die			
	Underbar parts & accessories			
	Cocktail station			
	Mug froster			
	Back bar cooler			
	Back bar keg cooler			
	Back bar storage			
	Back bar margarita stand			
	Back bar ice display unit			
	Back bar liquor display unit			
	Cleaner			
	Cleaning equipment			
	Faucet brush			
	Faucet wrench			
	Faucet lock			
	Pigtail			
	Splicers			
	Y fittings			
	U bends / 90° bend			
	Hose nipples			
	Hose clamps			
	Hex nuts			
	Washers			